

# Technical Data Sheet

## S303D Stainless Steel Piano “Continuous” Hinge 38x1.0x1830mm

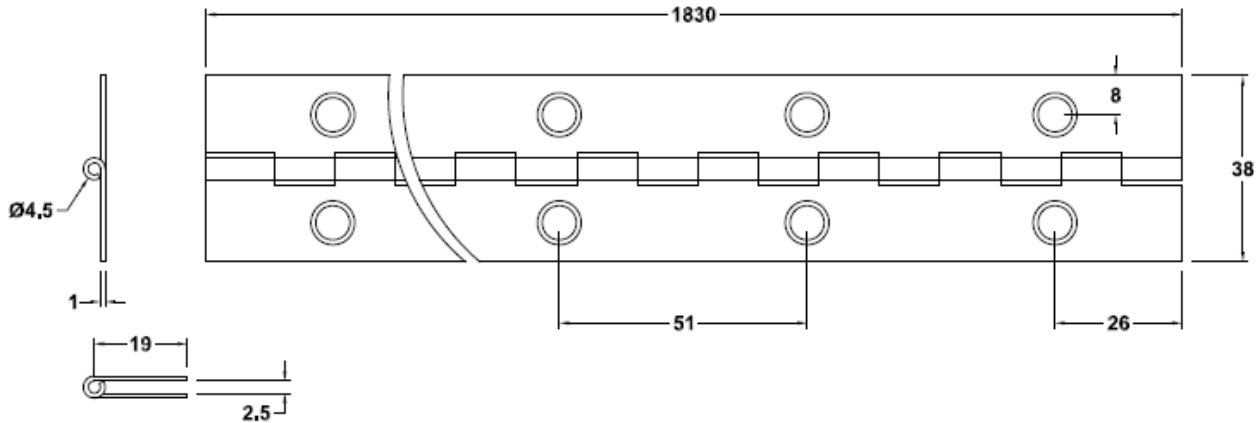

### SPECIFICATION

- **Hinge Type:** Continuous Piano Hinge
- **Material:** Stainless Steel 304 grade
- **Hinge Pin:** 2.4mm Diameter Stainless Steel 304 grade
- **Knuckle:** Round 4.5 Diameter
- **Fixing Holes:** Pre-drilled fixing Holes – 35 holes at 51mm centre's
- **Endcaps:** N/A
- **Fire Rated:** N/A

### FINISH

- S303DSSS – Satin Stainless Steel

### INSTALLATION GUIDE

- Door Thickness: N/A
- Suitable for Timber or Metal doors cabinet / furniture doors
- Can be cut to length to suit door height

### FIXING

- Fastening screws **NOT** supplied