

Technical Data Sheet

S305D Stainless Steel Piano “Continuous” Hinge 76x1.6x1830mm

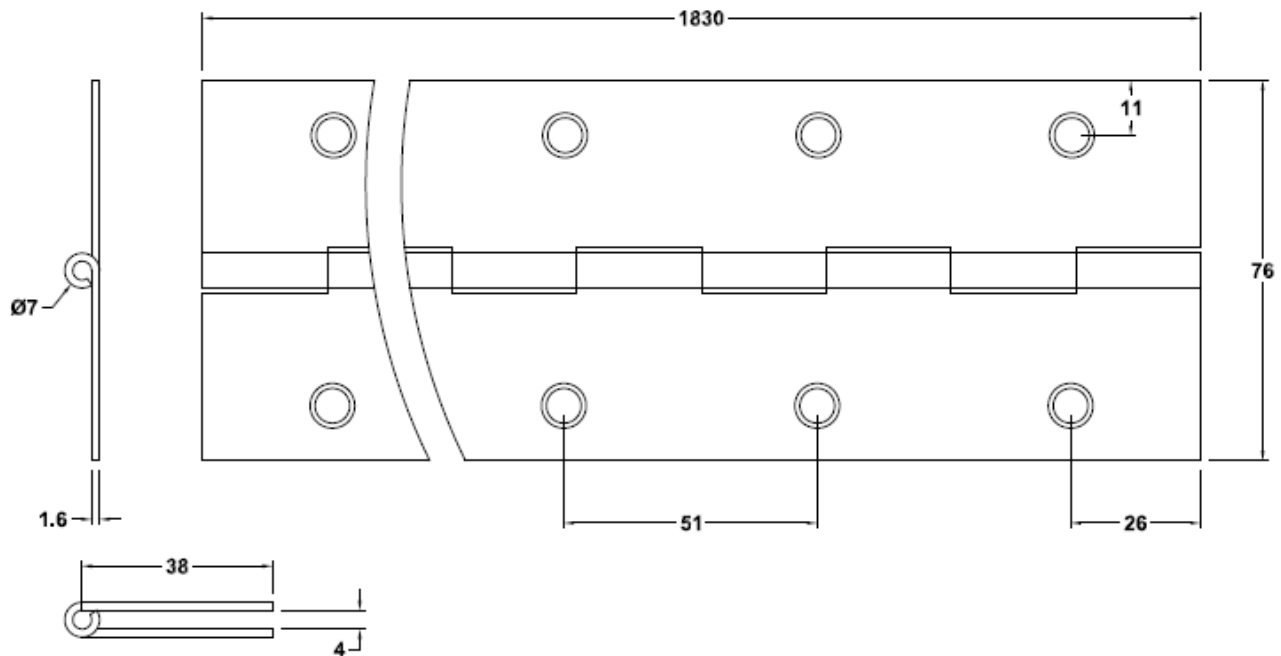

SPECIFICATION

- **Hinge Type:** Continuous Piano Hinge
- **Material:** Stainless Steel 304 grade
- **Hinge Pin:** 3.9mm Diameter Stainless Steel 304 grade
- **Knuckle:** Round 7.0 Diameter
- **Fixing Holes:** Pre-drilled fixing Holes – 35 holes at 51mm centre's
- **Endcaps:** N/A
- **Fire Rated:** N/A

FINISH

- S305DSSS – Satin Stainless Steel

INSTALLATION GUIDE

- Door Thickness: N/A
- Suitable for Timber or Metal doors
- Load is distributed over the entire length of the hinge making it suitable for heavier doors
- Can be cut to length to suit door height

FIXING

- Fastening screws **NOT** supplied