



Quality Products Since 1939

The background of the central section is a light gray architectural floor plan. It shows various rooms and areas with labels such as "ROOM", "BALCONY", "STORAGE", "LAUNDRY", "OFF", "M7", "M70", "AD15", "AWB", "AW2A", "WD1", "AW1", "AW2", "AW3", "AW4", "AW5", "AW6", "AW7", "AW8", "AW9", "AW10", "AW11", "AW12", "AW13", "AW14", "AW15", "AW16", "AW17", "AW18", "AW19", "AW20", "AW21", "AW22", "AW23", "AW24", "AW25", "AW26", "AW27", "AW28", "AW29", "AW30", "AW31", "AW32", "AW33", "AW34", "AW35", "AW36", "AW37", "AW38", "AW39", "AW40", "AW41", "AW42", "AW43", "AW44", "AW45", "AW46", "AW47", "AW48", "AW49", "AW50", "AW51", "AW52", "AW53", "AW54", "AW55", "AW56", "AW57", "AW58", "AW59", "AW60", "AW61", "AW62", "AW63", "AW64", "AW65", "AW66", "AW67", "AW68", "AW69", "AW70", "AW71", "AW72", "AW73", "AW74", "AW75", "AW76", "AW77", "AW78", "AW79", "AW80", "AW81", "AW82", "AW83", "AW84", "AW85", "AW86", "AW87", "AW88", "AW89", "AW90", "AW91", "AW92", "AW93", "AW94", "AW95", "AW96", "AW97", "AW98", "AW99", "AW100".

**Locks &
Door Furniture**

www.mccallumhinges.com.au

sales@mccallumhinges.com.au

02 9698 5111

About McCallum Australia

McCallum Australia has been manufacturing high quality hardware products for the Australian market since 1939.

Our products are designed and developed in Australia, made from the highest quality materials and processes to exceed the high demands of Australian Standards and the market.

McCallum Australia is the pre-eminent hinge manufacturer for Australia. Our products have been used in hundreds of thousands of projects across Australia – including some of the most prominent such as, The Sydney Opera House, New Parliament House Canberra, and Crown Casino.

McCallum's pioneered the extruded aluminium hinge that features aluminium pressed endcaps, keyed flanged nylon bearings and stainless-steel hinge pins. We have included these innovative design features in our popular heavy duty fast-fix hinge range.

Our range of products are used extensively throughout the Australian market and are sort after by tradespeople, specifiers and technicians for new projects, repairs, refurbishments, and retrofits.

McCallum Australia products are sought for their key attributes:

- Quality
- Reliability
- Technical innovation
- Value

We support this with a focus on strong customer support.

McCallum representatives and stockists would be pleased to discuss and offer advice regarding your hardware requirements.

For additional technical information please contact us

+61 2 9698 5111

sales@mccallumhinges.com.au



Contents

About McCallum Australia	1
2: Locks	3
2.1: 10000 Series Commercial Mortice Lock	4
2.2: 11000 Series Narrow Stile Commercial Mortice Locks.....	18
2.3: 12000 Series Narrow Stile Commercial Mortice Locks.....	28
2.4: Commercial Mortice Lock Cylinders & Accessories	40
2.5: Euro Mortice Locks	41
2.6: Euro Cylinders.....	42
3: Door Furniture.....	44
3.1: 3000 Series Long Plate Door Furniture	45
3.2: 4000 Series Narrow Stile Long Plate Door Furniture.....	49
3.3: 5000 Series Rosette Door Furniture.....	55
3.4: 5500 Series Euro Long Plate Door Furniture	59
Notes:	61

2: Locks



2.1: 10000 Series Commercial Mortice Lock

The McCallum 10000 Series commercial mortice locks have been manufactured to meet the requirements of the Australian market. Using high quality materials to meet the durability and strength required for use in commercial and industrial building applications.

The 10000 series is a multi-functional lock that allows for simple switching between vestibule and combination locking functions by an external operation prior to installation.



SPECIFICATION

Lock Case:

Material high purity zinc alloy

Face Plate:

Stainless Steel 304 grade

Strike Plate:

Universal "T" Strike plate - Stainless Steel 304 grade

Backset:

Standard 60mm

Door Thickness:

32 - 50mm

Latchbolt:

Stainless Steel 15mm projection

Auxiliary bolt:

Stainless Steel activates dead latching.

Handing:

Reversible latchbolt (non-handed)

Spindle Hub:

Accepts 7.6mm spindles.

Cylinder:

Oval Brass outer Cylinder and inner Barrel

Cylinder retention:

Spring Steel Retaining Pin

Operation:

Multi-functional lock body allowing for simple switching from combination to vestibule locking functions.

Durability:

10000 Series Commercial Mortice Locks conform with level D8 (Durability) Australian Lock Standard (AS 4145.2-2008).

Security:

10000 Series Commercial Mortice Locks conform with level S5 (Physical Security) Australian Lock Standard (AS 4145.2-2008).

**Fire Rated:**

Successfully tested in accordance with Australian Lock Standard (AS 1905.1-2015).

Electric Strikes:

The 10000 Series Commercial Mortice Locks are compatible with most electric strikes.

Warranty:

10 Year mechanical

Finishes:

SSS: Satin Stainless Steel

BLK: Black

10000 series Lock Dimensions

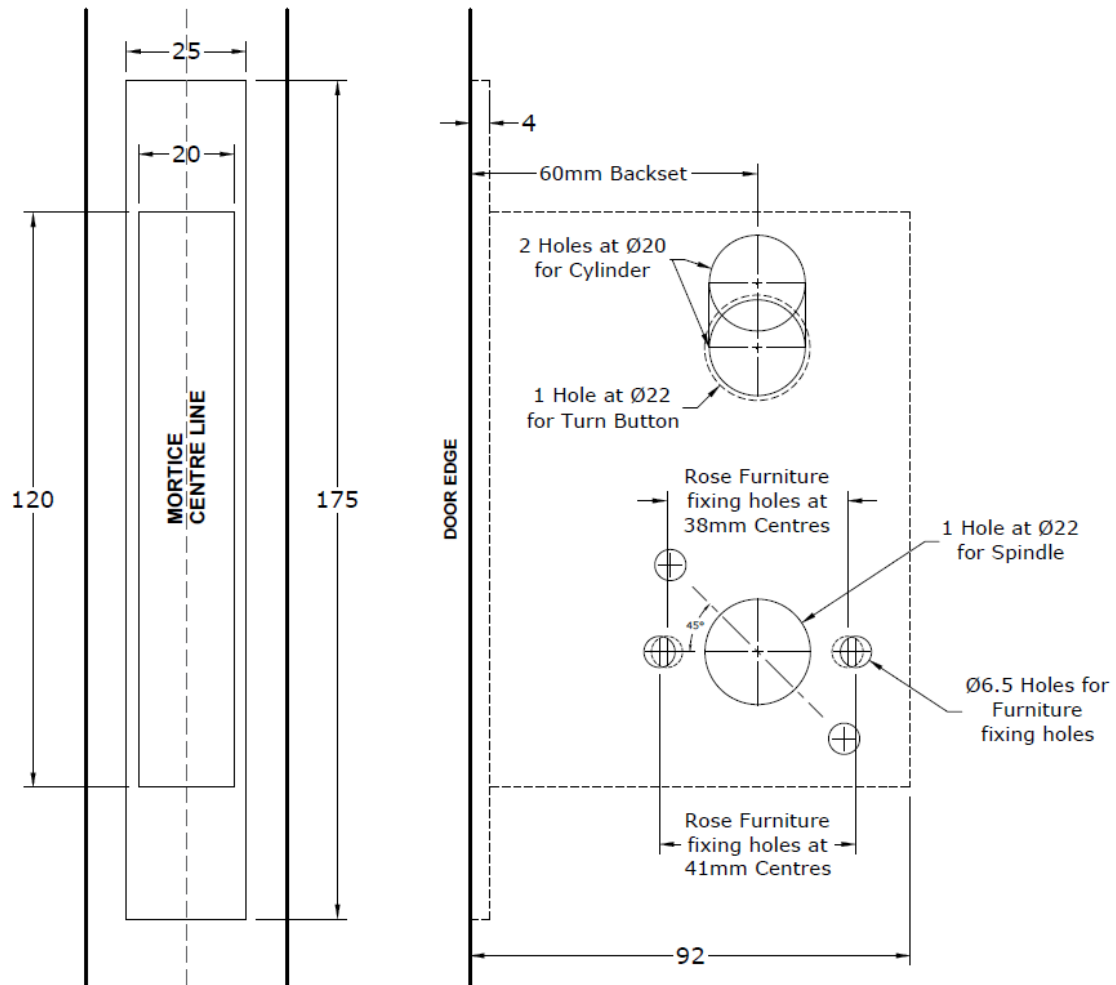
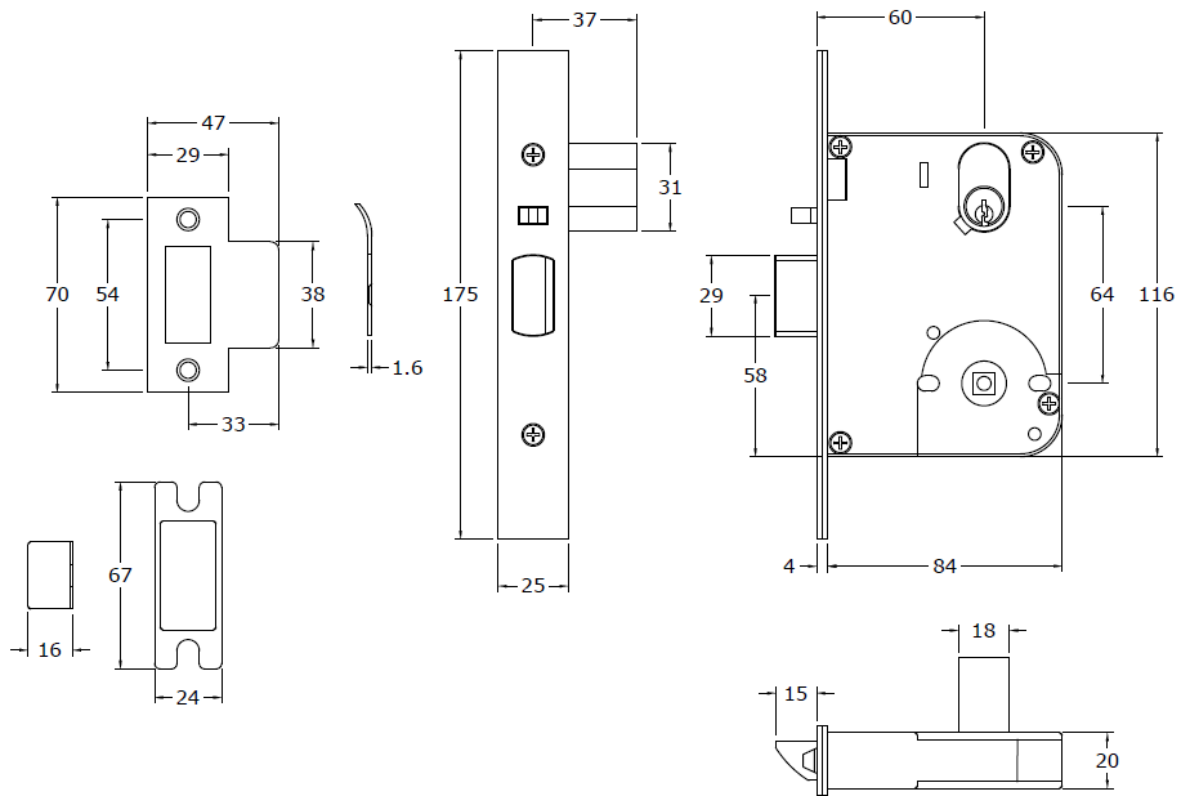

10100 Vestibule Function

ENTRANCE / OFFICE DOOR

PRODUCT CODE	DESCRIPTION
10116	Entrance / Office Door Lock

FUNCTION

OUTSIDE:	Key retracts latchbolt
INSIDE:	Turn Button locks & unlocks the outside handle Inside handle free at all times

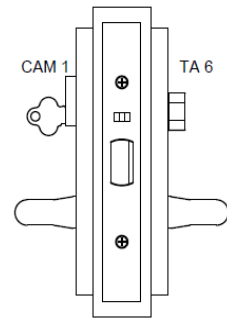

ENTRANCE

PRODUCT CODE	DESCRIPTION
10156	Entrance Door Lock

FUNCTION

OUTSIDE:	Key locks & unlock outside handle
INSIDE:	Turn Button locks & unlocks outside handle Inside handle free at all times

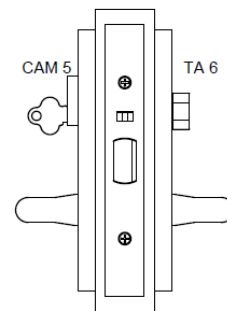

STOREROOM DOOR

PRODUCT CODE	DESCRIPTION
10110	Storeroom Door Lock

FUNCTION

OUTSIDE:	Key retracts the latchbolt outside handle inoperative
INSIDE:	Inside handle free at all times

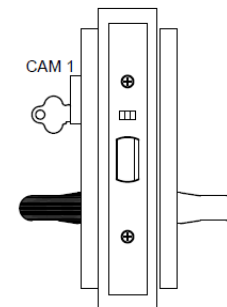

CLASSROOM/OFFICE DOOR

PRODUCT CODE	DESCRIPTION
10120	Classroom / Office Door Lock

FUNCTION

OUTSIDE:	Key locks & unlocks outside handle
INSIDE:	Inside handle free at all times

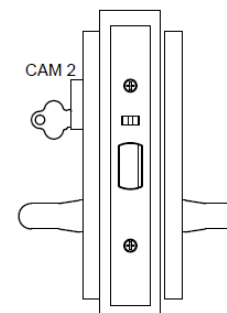

EXIT DOOR

PRODUCT CODE
10102

DESCRIPTION
Exit Door Lock

FUNCTION

OUTSIDE: Outside handle retracts latchbolt when unlocked from the inside

INSIDE: Key locks & unlocks outside handle
Inside handle free at all times

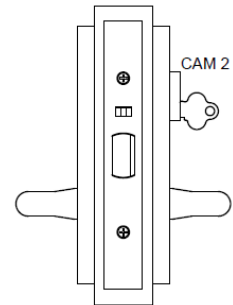

EXIT DOOR

PRODUCT CODE
10106

DESCRIPTION
Exit Door Lock

FUNCTION

OUTSIDE: Outside handle retracts latchbolt when unlocked from the inside

INSIDE: Turn Button locks & unlocks outside handle
Inside handle free at all times

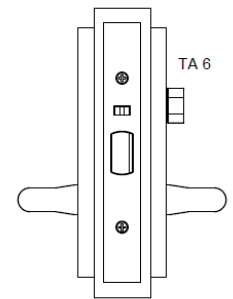

EXIT DOOR LATCH

PRODUCT CODE
10100

DESCRIPTION
Exit Door Lock

FUNCTION

OUTSIDE: Outside handle inoperative

INSIDE: Inside handle free at all times

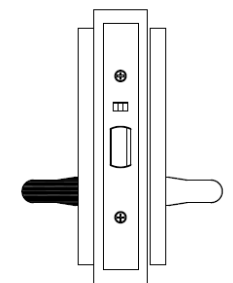

PRIVACY DOOR

PRODUCT CODE
10106

DESCRIPTION
Privacy Door Lock

FUNCTION

OUTSIDE: Emergency release button unlocks outside handle

INSIDE: Turn button locks & unlocks outside handle
Inside handle free at all times

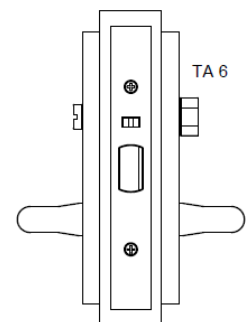

10200 Combination Function

ENTRANCE / OFFICE DOOR

PRODUCT CODE	DESCRIPTION
10216	Entrance / Office Door Lock

FUNCTION

OUTSIDE:	Key retracts latchbolt
INSIDE:	Turn Button locks & unlocks both handles

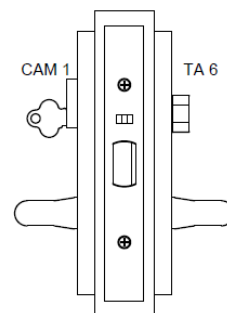

ENTRANCE DOOR

Product Code	Description
10256	Entrance Door Lock

FUNCTION

OUTSIDE:	Key locks & unlocks both handles
INSIDE:	Turn Button locks & unlocks both handles

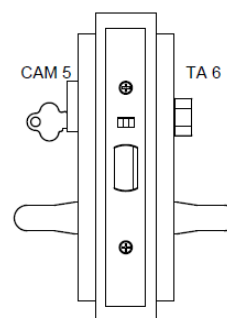

GLASS DOOR

PRODUCT CODE	DESCRIPTION
10222	Glass Door Lock

FUNCTION

OUTSIDE:	Key locks & unlocks both handles
INSIDE:	Key locks & unlocks both handles

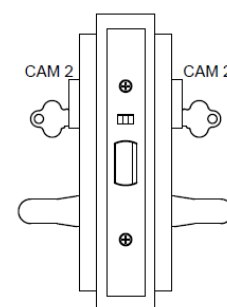

PATIO DOOR

PRODUCT CODE	DESCRIPTION
10206	PATIO Door Lock

FUNCTION

OUTSIDE:	Outside handle operates when unlocked from the inside
INSIDE:	Turn Button locks & unlocks both handles

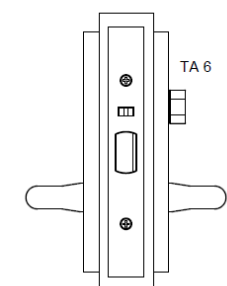

PASSAGE DOOR**PRODUCT CODE**

10200

DESCRIPTION

Passage Door Latch

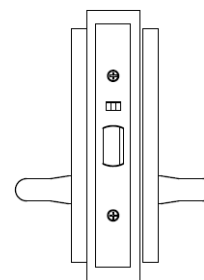
FUNCTION**OUTSIDE:** Handle retracts the latchbolt**INSIDE:** Handle retracts the latchbolt

Product Code	Description	Finish
Vestibule Functions		
10116	Entrance / Office Door Lock	SSS, BLK
10156	Entrance Door Lock	SSS, BLK
10110	Storeroom Door Lock	SSS, BLK
10120	Classroom / Office Door Lock	SSS, BLK
10102	Exit Door Lock	SSS, BLK
10106	Exit Door Lock	SSS, BLK
10100	Exit Door Latch	SSS, BLK
10106	Privacy Door Lock	SSS, BLK
Combination Functions		
10216	Entrance / Office Door Lock	SSS, BLK
10256	Entrance Door Lock	SSS, BLK
10222	Glass Door Lock	SSS, BLK
10206	Patio Door Lock	SSS, BLK
10200	Passage Door Latch	SSS, BLK

10000 series Lock & 3000 series Door Furniture Kits

10L27-00 PRIMARY VEST/COMB LOCK & DOOR FURNITURE KIT

LOCK FUNCTION

PASSAGE LATCH



Fire Rated

Kit inclusions:

- 10000 Primary Vest/Comb Lock
- P3127 External Plate Cylinder & Lever 27
- P3227 Internal Plate Cylinder & Lever 27

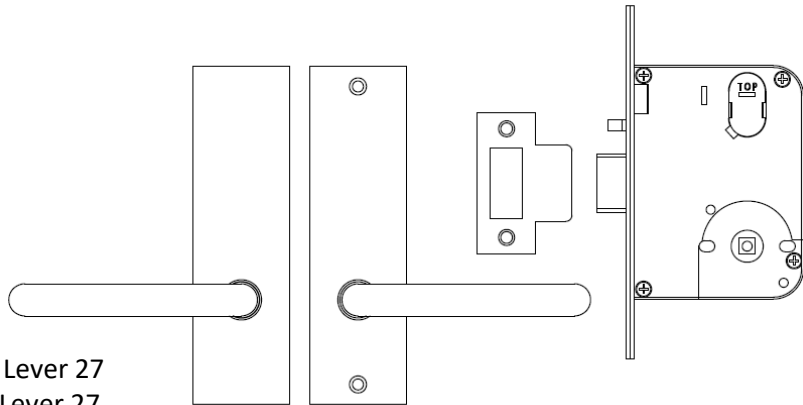

10L27-01 SINGLE CYLINDER & TURN LOCK & DOOR FURNITURE KIT

LOCK FUNCTION

ENTRANCE / OFFICE DOOR LOCK



Fire Rated

Kit inclusions:

- 10000 Primary Vest/Comb Lock
- CML-05 Oval Cylinder #5 Cam
- CML-CAM1 #1 Cylinder Cam
- CML-TA6 #6 Turn Adaptor
- P3127 External Plate Cylinder & Lever 27
- P3627 Internal Plate Turn Button & Lever 27

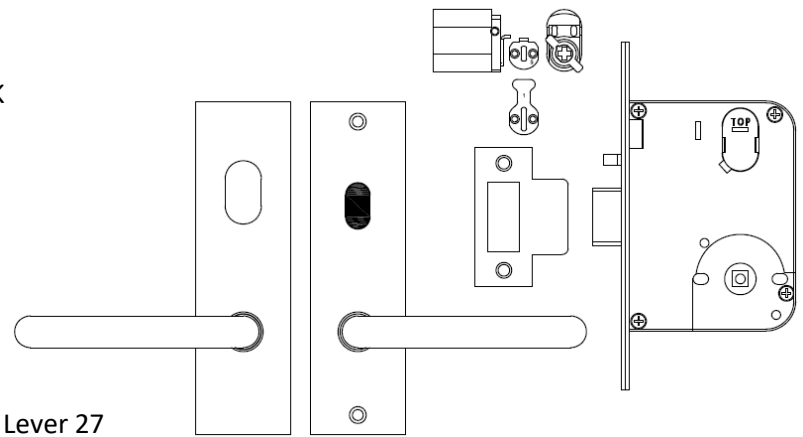

10L27-02 DOUBLE CYLINDER LOCK & DOOR FURNITURE KIT

LOCK FUNCTION

GLASS DOOR LOCK



Fire Rated

Kit inclusions:

- 10000 Primary Vest/Comb Lock
- CML-02 Oval Cylinder #2 Cam x 2
- CML-CAM1 #1 Cylinder Cam
- P3127 External Plate Cylinder & Lever 27
- P3227 Internal Plate Cylinder & Lever 27

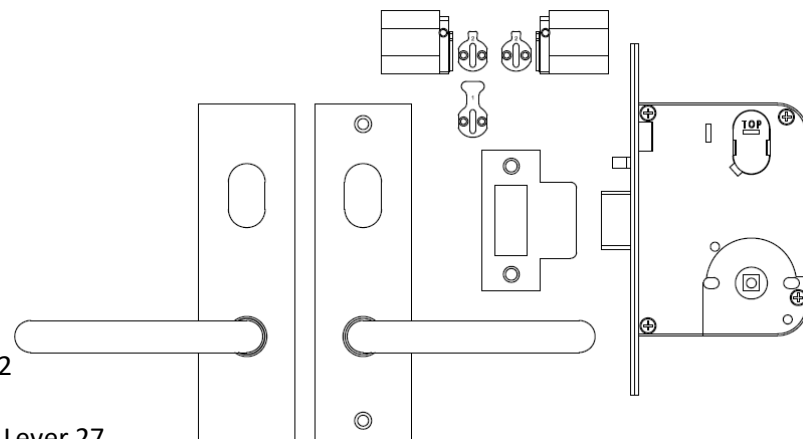

10L27-03 SINGLE CYLINDER LOCK & DOOR FURNITURE KIT

LOCK FUNCTION

CLASSROOM / STOREROOM DOOR LOCK



Fire Rated

Kit inclusions:

- 10000 Primary Vest/Comb Lock
- CML-02 Oval Cylinder #2 Cam
- CML-CAM1 #1 Cylinder Cam
- P3127 External Plate Cylinder & Lever 27
- P3427 Internal Plate Plain & Lever 27

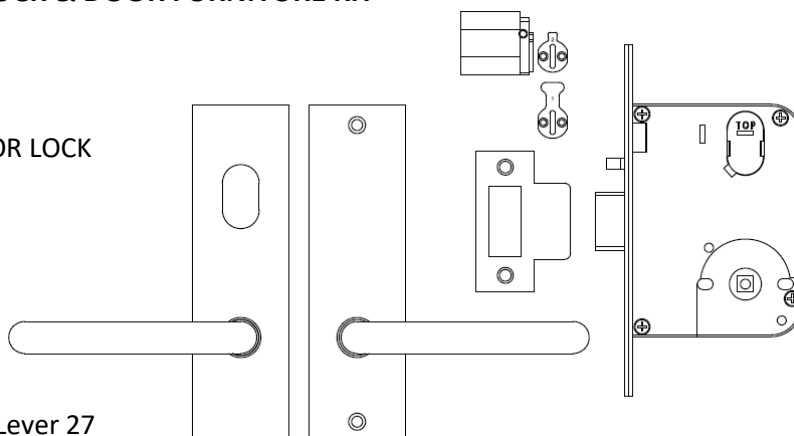

10L27-04 EXTERIOR EXIT SINGLE CYLINDER LOCK & DOOR FURNITURE KIT

LOCK FUNCTION

EXIT DOOR LOCK



Fire Rated

Kit inclusions:

- 10000 Primary Vest/Comb Lock
- CML-01 Oval Cylinder #1 Cam
- P3002 External Plate Cylinder only
- P3427 Internal Plate Plain & Lever 27

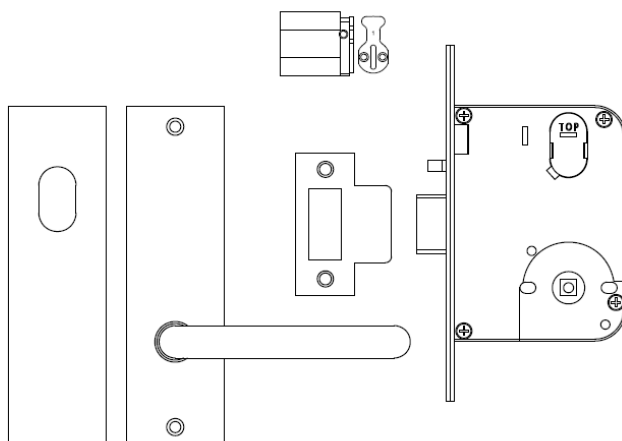

Product Code	Description	Finish
10L27-00	Primary Vest/Comb Lock + Door Furniture Kit	SSS, BLK
10L27-01	Single Cylinder, Turn Lock + Door Furniture Kit	SSS, BLK
10L27-02	Double Cylinder Lock + Door Furniture Kit	SSS, BLK
10L27-03	Single Cylinder Lock + Door Furniture Kit	SSS, BLK
10L27-04	Exterior Exit Single Cylinder Lock + Door Furniture Kit	SSS, BLK

10L27-156LC ENTRANCE / OFFICE DOOR LOCK & DOOR FURNITURE KIT LESS CYLINDER



Fire Rated

Kit inclusions:

- 10000 Primary Vestibule/Combination Lock
- CML-CAM1 #1 Cylinder Cam
- CML-CAM5 #5 Cylinder Cam
- CML-TA6 #6 Turn Adaptor
- P3127 External Plate Cylinder & Lever 27
- P3627 Internal Plate Turn Button & Lever 27

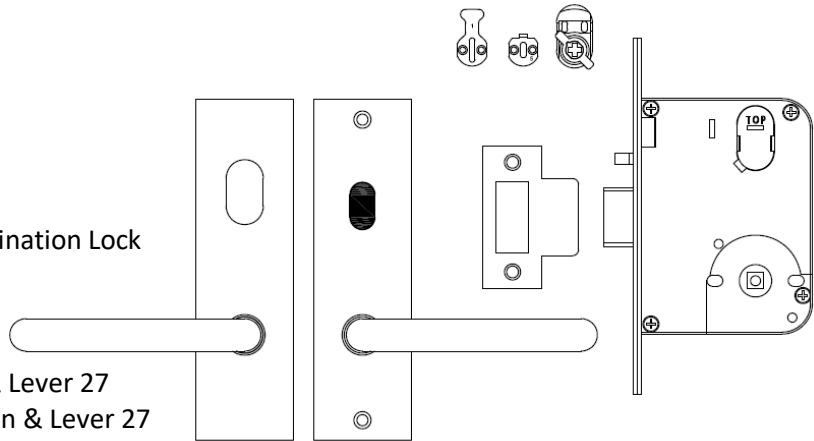

10L27-221LC DOUBLE CYLINDER LOCK & DOOR FURNITURE KIT LESS CYLINDER



Fire Rated

Kit inclusions:

- 10000 Primary Vestibule/Combination Lock
- CML-CAM2 #2 Cylinder Cam x 2
- CML-CAM1 #1 Cylinder Cam
- P3127 External Plate Cylinder & Lever 27
- P3227 Internal Plate Cylinder & Lever 27

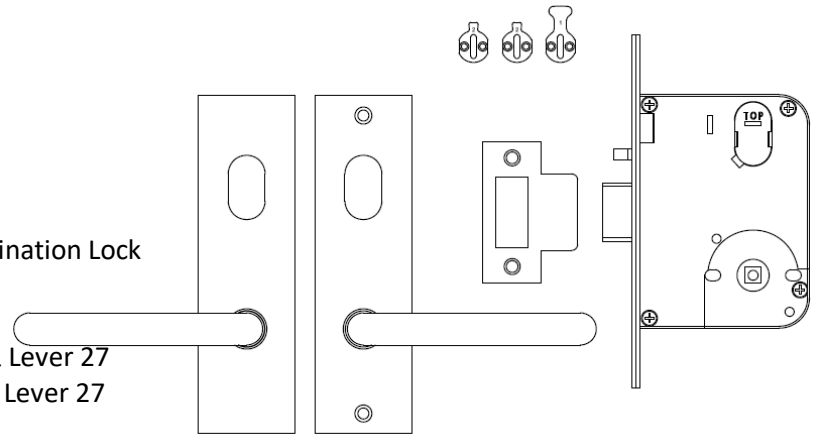

10L27-12LC SINGLE CYLINDER LOCK & DOOR FURNITURE KIT LESS CYLINDER



Fire Rated

Kit inclusions:

- 10000 Primary Vestibule/Combination Lock
- CML-CAM1 #1 Cylinder Cam
- CML-CAM2 #2 Cylinder Cam
- P3127 External Plate Cylinder & Lever 27
- P3427 Internal Plate Plain & Lever 27

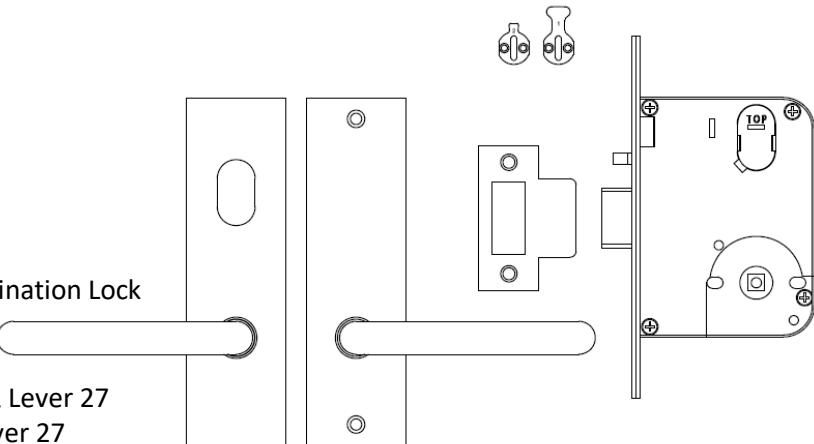

Product Code	Description	Finish
10L27-156LC	Single Cylinder & Turn Lock + Door Furniture Kit (Less Cyl)	SSS, BLK
10L27-22LC	Double Cylinder Lock & Door Furniture Kit (Less Cyl)	SSS, BLK
10L27-12LC	Single Cylinder Lock & Door Furniture Kit (Less Cyl)	SSS, BLK

10000 series Lock & 5000 series Door Furniture Kits

10R26-00 PRIMARY VEST/COMB LOCK & DOOR FURNITURE KIT

LOCK FUNCTION



Fire Rated

Kit inclusions:

10000 Primary Vest/Comb Lock
R5126 Passage Set Round Rosette - Lever 26

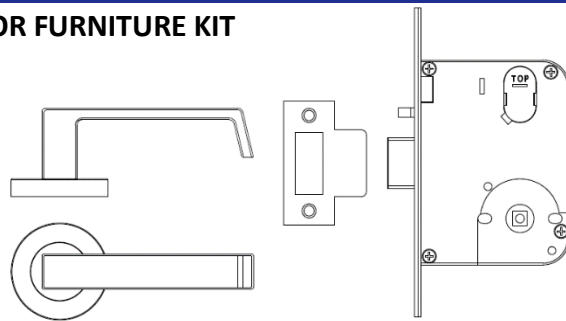

10R26-01 SINGLE CYLINDER & TURN LOCK & DOOR FURNITURE KIT

LOCK FUNCTION

ENTRANCE / OFFICE DOOR LOCK



Fire Rated

Kit inclusions:

10000 Primary Vestibule/Combination Lock
CML-CAM1 #1 Cylinder Cam
CML-OC5 #5 Oval Cylinder #5 Cam
CML-TA6 #6 Turn Adaptor
R5126 Passage Set Round Rosette - Lever 26
R50E1 Round Oval Cylinder Escutcheon
R50T3 Round Turn Button Escutcheon

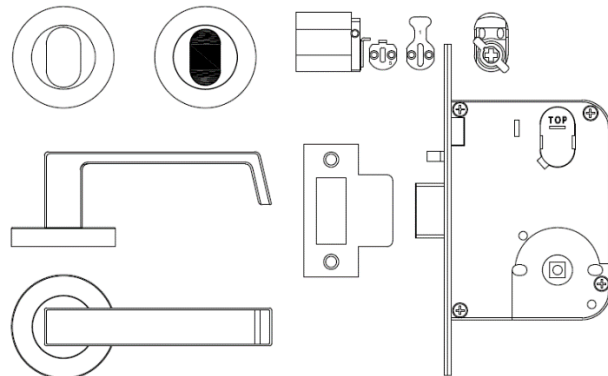

10R26-02 DOUBLE CYLINDER LOCK & DOOR FURNITURE KIT

LOCK FUNCTION

GLASS DOOR LOCK



Fire Rated

Kit inclusions:

10000 Primary Vestibule/Combination Lock
CML-OC2 Oval Cylinders #2 Cam x 2
CML-CAM1 #1 Cylinder Cam
R5126 Passage Set Round Rosette - Lever 26
R50E1 Round Oval Cylinder Escutcheon x 2

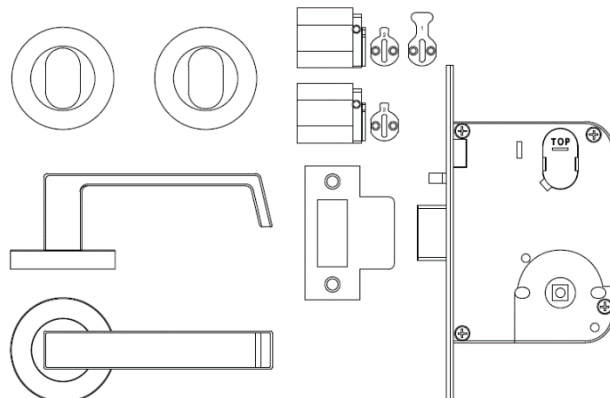

10R26-03 SINGLE CYLINDER LOCK & DOOR FURNITURE KIT

LOCK FUNCTION

CLASSROOM / STOREROOM DOOR LOCK



Fire Rated

Kit inclusions:

10000 Primary Vestibule/Combination Lock
CML-OC1 Oval Cylinder #1 Cam
CML-CAM2 #2 Cylinder Cam
R5126 Passage Set Round Rosette - Lever 26
R50E1 Round Oval Cylinder Escutcheon

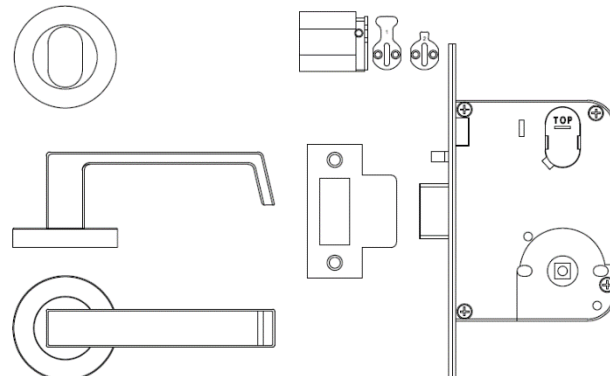

10R27-00 PRIMARY VEST/COMB LOCK & DOOR FURNITURE KIT

LOCK FUNCTION

PASSAGE LATCH



Fire Rated

Kit inclusions:

10000 Primary Vest/Comb Lock
R5127 Passage Set Round Rosette - Lever 27

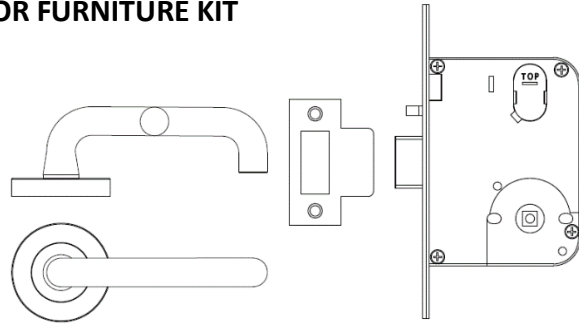

10R27-01 SINGLE CYLINDER & TURN LOCK & DOOR FURNITURE KIT

LOCK FUNCTION

ENTRANCE / OFFICE DOOR LOCK



Fire Rated

Kit inclusions:

10000 Primary Vestibule/Combination Lock
CML-CAM1 #1 Cylinder Cam
CML-OC5 #5 Oval Cylinder #5 Cam
CML-TA6 #6 Turn Adaptor
R5127 Passage Set Round Rosette - Lever 27
R50E1 Round Oval Cylinder Escutcheon
R50T3 Round Turn Button Escutcheon

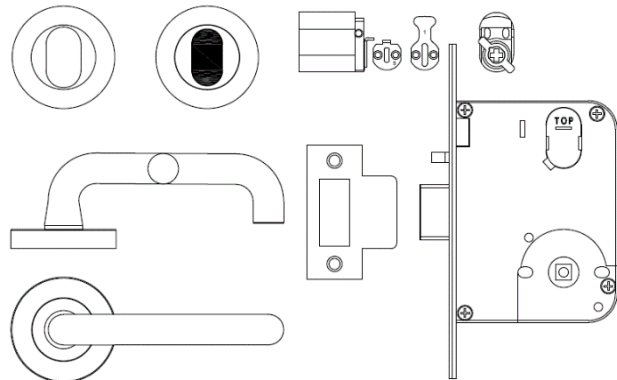

10R27-221 DOUBLE CYLINDER LOCK & DOOR FURNITURE KIT

LOCK FUNCTION

GLASS DOOR LOCK



Fire Rated

Kit inclusions:

10000 Primary Vestibule/Combination Lock
CML-OC2 Oval Cylinders #2 Cam x 2
CML-CAM1 #1 Cylinder Cam
R5127 Passage Set Round Rosette - Lever 27
R50E1 Round Oval Cylinder Escutcheon x 2

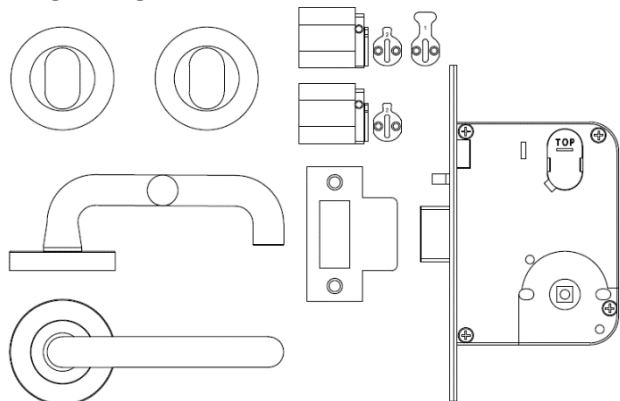

10R27-12 SINGLE CYLINDER LOCK & DOOR FURNITURE KIT

LOCK FUNCTION

CLASSROOM / STOREROOM DOOR LOCK



Fire Rated

Kit inclusions:

10000 Primary Vestibule/Combination Lock
CML-OC1 Oval Cylinder #1 Cam
CML-CAM2 #2 Cylinder Cam
R5127 Passage Set Round Rosette - Lever 27
R50E1 Round Oval Cylinder Escutcheon

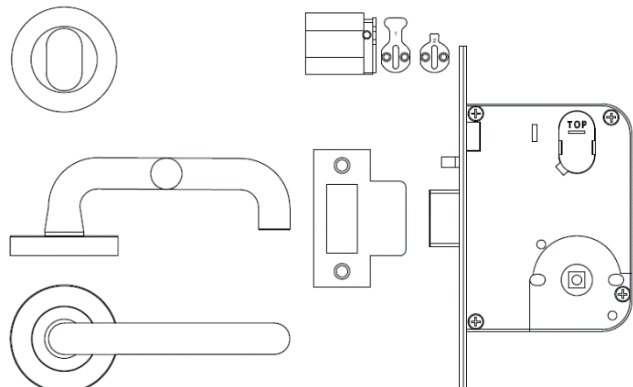

Product Code	Description	Finish
10R26-00	Primary Vest/Comb Lock + Door Furniture Kit	SSS, BLK
10R26-01	Single Cylinder, Turn Lock + Door Furniture Kit	SSS, BLK
10R26-02	Double Cylinder Lock + Door Furniture Kit	SSS, BLK
10R26-03	Single Cylinder Lock + Door Furniture Kit	SSS, BLK
<hr/>		
10R27-00	Primary Vest/Comb Lock + Door Furniture Kit	SSS, BLK
10R27-01	Single Cylinder, Turn Lock + Door Furniture Kit	SSS, BLK
10R27-02	Double Cylinder Lock + Door Furniture Kit	SSS, BLK
10R27-03	Single Cylinder Lock + Door Furniture Kit	SSS, BLK

10R26-156LC ENTRANCE / OFFICE DOOR LOCK & DOOR FURNITURE KIT LESS CYLINDER



Fire Rated

Kit inclusions:

- 10000 Primary Vestibule/Combination Lock
- CML-CAM1 #1 Cylinder Cam
- CML-CAM5 #5 Cylinder Cam
- CML-TA6 #6 Turn Adaptor
- R5126 Passage Set Round Rosette - Lever 26
- R50E1 Round Oval Cylinder Escutcheon
- R50T3 Round Turn Button Escutcheon

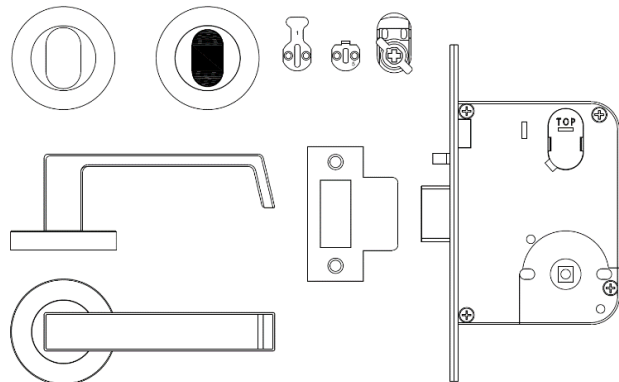

10R26-221LC DOUBLE CYLINDER LOCK & DOOR FURNITURE KIT LESS CYLINDER



Fire Rated

Kit inclusions:

- 10000 Primary Vestibule/Combination Lock
- CML-CAM2 #2 Cylinder Cam x 2
- CML-CAM1 #1 Cylinder Cam
- R5126 Passage Set Round Rosette - Lever 26
- R50E1 Round Oval Cylinder Escutcheon x 2

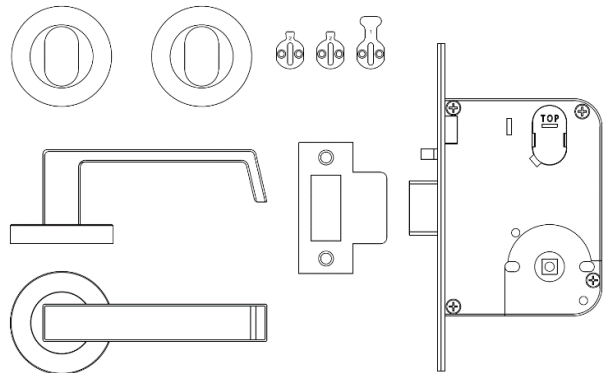

10L26-12LC SINGLE CYLINDER LOCK & DOOR FURNITURE KIT LESS CYLINDER



Fire Rated

Kit inclusions:

- 10000 Primary Vestibule/Combination Lock
- CML-CAM1 #1 Cylinder Cam
- CML-CAM2 #2 Cylinder Cam
- R5126 Passage Set Round Rosette - Lever 26
- R50E1 Round Oval Cylinder Escutcheon

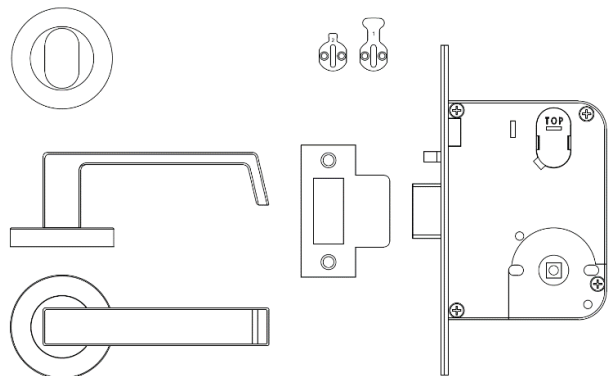

Product Code	Description	Finish
10R26-156LC	Single Cylinder & Turn Lock + Door Furniture Kit (Less Cyl)	SSS, BLK
10R26-22LC	Double Cylinder Lock & Door Furniture Kit (Less Cyl)	SSS, BLK
10R26-12LC	Single Cylinder Lock & Door Furniture Kit (Less Cyl)	SSS, BLK

10R27-156LC ENTRANCE / OFFICE DOOR LOCK & DOOR FURNITURE KIT LESS CYLINDER



Fire Rated

Kit inclusions:

- 10000 Primary Vestibule/Combination Lock
- CML-CAM1 #1 Cylinder Cam
- CML-CAM5 #5 Cylinder Cam
- CML-TA6 #6 Turn Adaptor
- R5127 Passage Set Round Rosette - Lever 27
- R50E1 Round Oval Cylinder Escutcheon
- R50T3 Round Turn Button Escutcheon

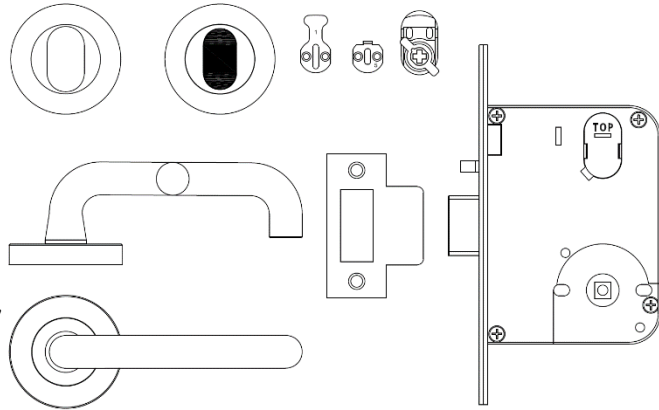

10R27-221LC DOUBLE CYLINDER LOCK & DOOR FURNITURE KIT LESS CYLINDER



Fire Rated

Kit inclusions:

- 10000 Primary Vestibule/Combination Lock
- CML-CAM2 #2 Cylinder Cam x 2
- CML-CAM1 #1 Cylinder Cam
- R5127 Passage Set Round Rosette - Lever 27
- R50E1 Round Oval Cylinder Escutcheon x 2

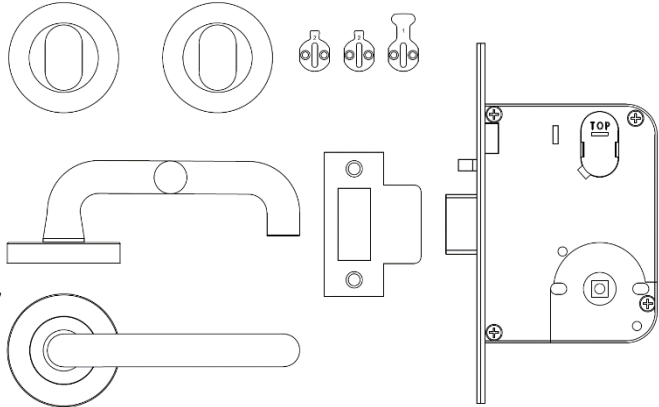

10L27-12LC SINGLE CYLINDER LOCK & DOOR FURNITURE KIT LESS CYLINDER



Fire Rated

Kit inclusions:

- 10000 Primary Vestibule/Combination Lock
- CML-CAM1 #1 Cylinder Cam
- CML-CAM2 #2 Cylinder Cam
- R5127 Passage Set Round Rosette - Lever 27
- R50E1 Round Oval Cylinder Escutcheon

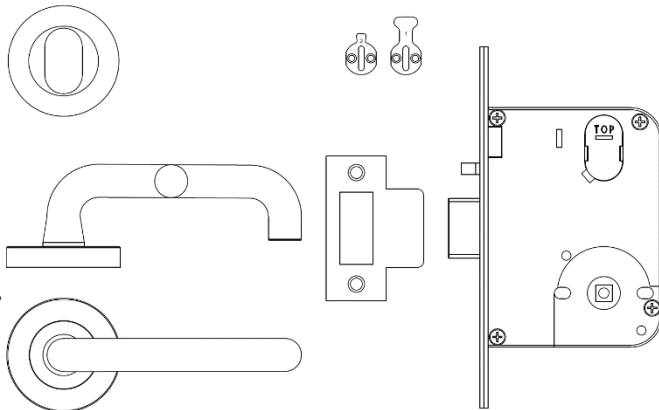

Product Code	Description	Finish
10R27-156LC	Single Cylinder & Turn Lock + Door Furniture Kit (Less Cyl)	SSS, BLK
10R27-22LC	Double Cylinder Lock & Door Furniture Kit (Less Cyl)	SSS, BLK
10R27-12LC	Single Cylinder Lock & Door Furniture Kit (Less Cyl)	SSS, BLK

2.2: 11000 Series Narrow Stile Commercial Mortice Locks

The McCallum 11000 and 12000 Series commercial mortice locks have been manufactured to meet the requirements of the Australian market. Using high quality materials to meet the durability and strength required for use in the commercial, industrial building and fabrication swing door market.

The 11000 and series locks are multi-functional allowing simple switching between vestibule and combination locking functions by an external operation prior to installation.



SPECIFICATION

Lock Case:

Material high purity zinc alloy

Face Plate:

Stainless Steel 304 grade

Strike Plate:

Stainless Steel 304 grade Universal "T"-strike plate

Backset:

11000 series 23mm backset

Door Thickness:

32 - 50mm

Latchbolt:

Stainless Steel 15mm projection

Auxiliary bolt:

Stainless Steel activates dead latching.

Handing:

Reversible latchbolt (non-handed)

Spindle Hub:

Accepts standard 7.6 x 7.6mm spindles.

Cylinder:

Oval Brass outer Cylinder and inner Barrel
C4-6 Pin Standard Keyway

Cylinder retention:

Threaded retaining screw.

Operation:

Multi-functional lock body allowing for simple switching from combination to vestibule lock functions.

Durability:

11000 Series Commercial Mortice Locks conform with level D8 (Durability) Australian Lock Standard (AS 4145.2-2008).

Security:

11000 Series Commercial Mortice Locks conform with level S5 (Physical Security) Australian Lock Standard (AS 4145.2-2008).

Electric Strikes:

The 11000 Series Commercial Mortice Locks are compatible with most electric strikes.

Warranty:

10 Year mechanical

Finishes:

SSS: Satin Stainless Steel
BLK: Black

11000 series Lock Dimensions

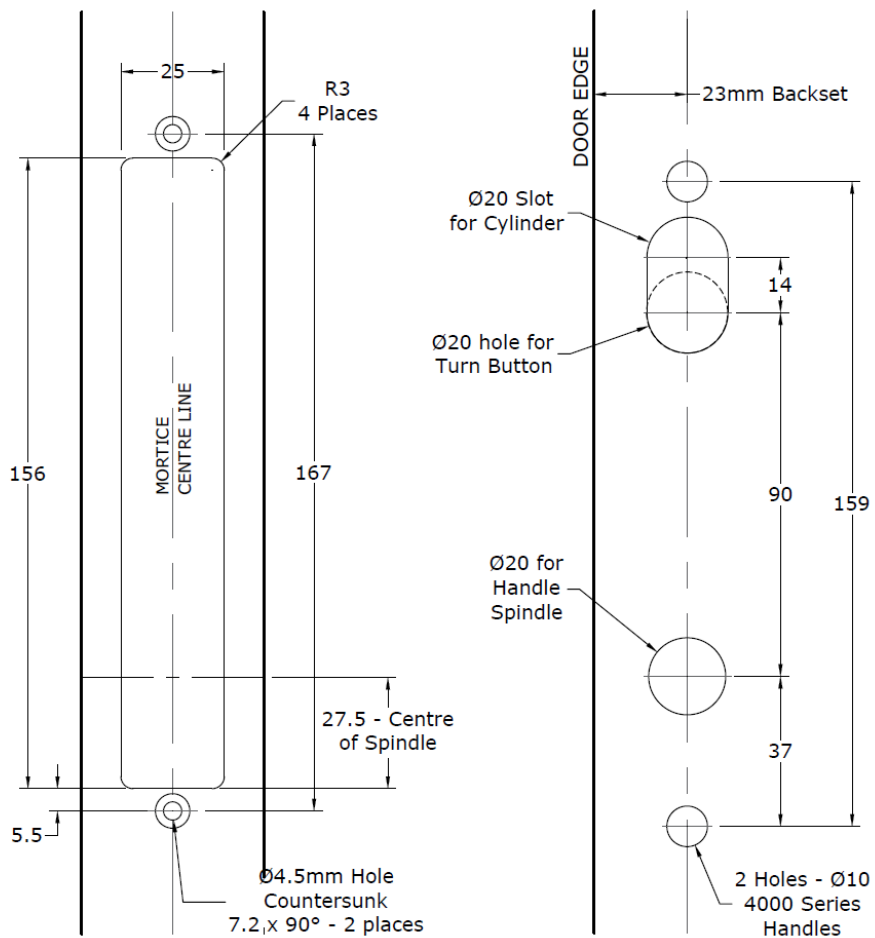
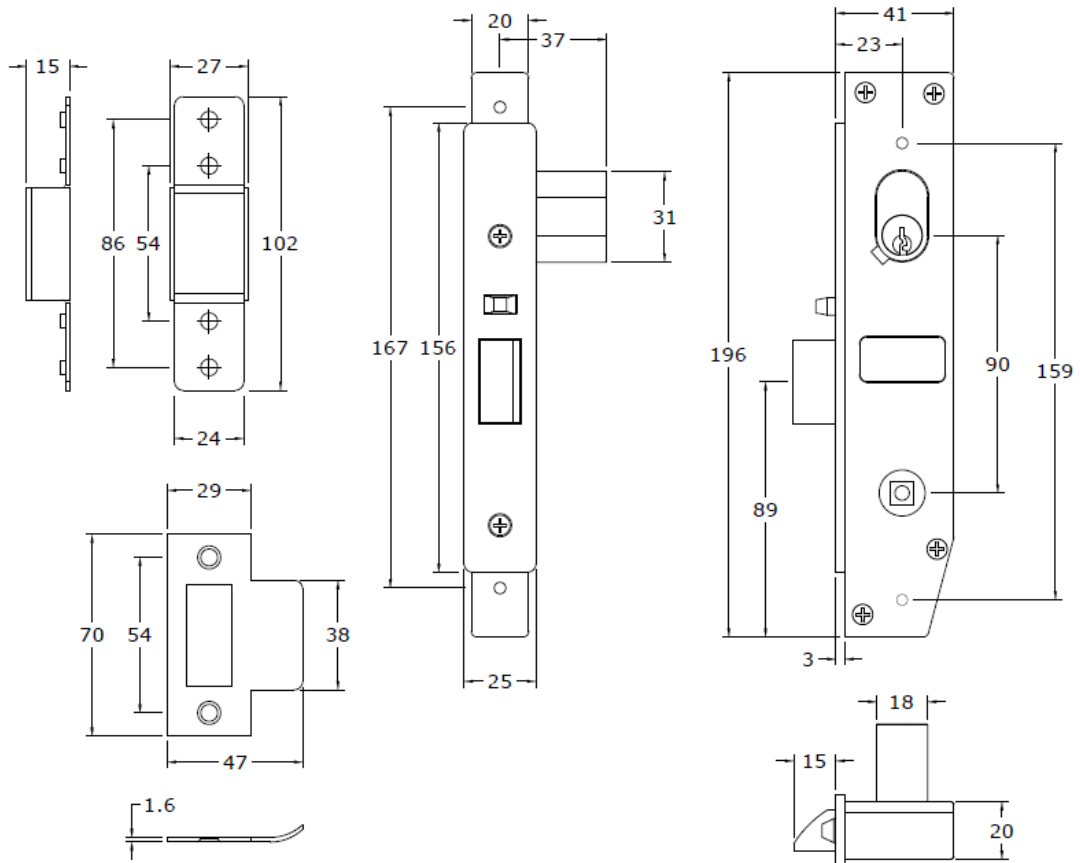

11100 Vestibule Function

ENTRANCE / OFFICE DOOR

PRODUCT CODE	DESCRIPTION
11116	Entrance / Office Door Lock

FUNCTION

OUTSIDE:	Key retracts latchbolt
INSIDE:	Turn Button locks & unlocks the outside handle Inside handle free at all times

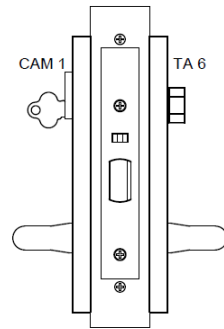

ENTRANCE DOOR

Product Code	Description
11156	Entrance Door Lock

FUNCTION

OUTSIDE:	Key locks & unlock outside handle
INSIDE:	Turn Button locks & unlocks outside handle Inside handle free at all times

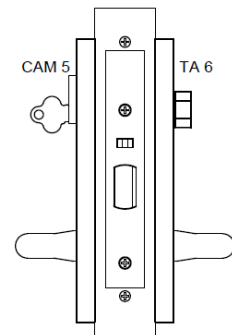

STOREROOM DOOR

PRODUCT CODE	DESCRIPTION
11110	Storeroom Door Lock

FUNCTION

OUTSIDE:	Key retracts the latchbolt outside handle inoperative
INSIDE:	Inside handle free at all times

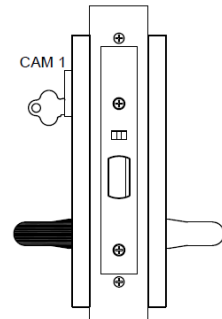

CLASSROOM / OFFICE DOOR

PRODUCT CODE	DESCRIPTION
11120	Classroom / Office Door Lock

FUNCTION

OUTSIDE:	Key locks & unlocks outside handle
INSIDE:	Inside handle free at all times

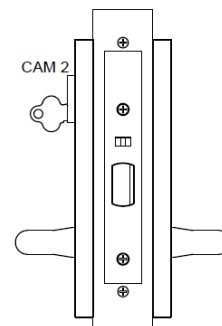

EXIT DOOR**PRODUCT CODE**

11102

DESCRIPTION

Exit Door Lock

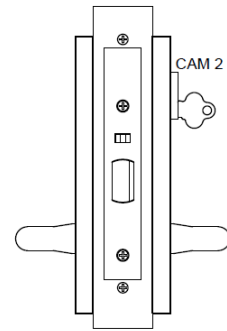
FUNCTION**OUTSIDE:** Outside handle retracts latchbolt when unlocked from the inside**INSIDE:** Key locks & unlocks outside handle
Inside handle free at all times

EXIT DOOR**PRODUCT CODE**

11106

DESCRIPTION

Exit Door Lock

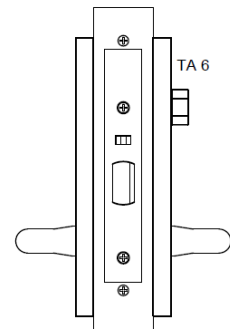
FUNCTION**OUTSIDE:** Outside handle retracts latchbolt when unlocked from the inside**INSIDE:** Turn Button locks & unlocks outside handle
Inside handle free at all times

EXIT DOOR LATCH**PRODUCT CODE**

11100

DESCRIPTION

Exit Door Lock

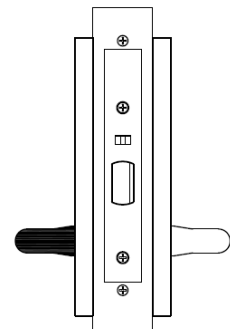
FUNCTION**OUTSIDE:** Outside handle inoperative**INSIDE:** Inside handle free at all times

11200 Combination Function

ENTRANCE / OFFICE DOOR

PRODUCT CODE	DESCRIPTION
11216	Entrance / Office Door Lock

FUNCTION

OUTSIDE:	Key retracts latchbolt
INSIDE:	Turn Button locks & unlocks both handles

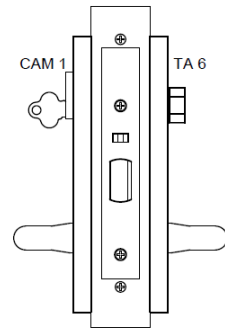

ENTRANCE DOOR

Product Code	Description
11256	Entrance Door Lock

FUNCTION

OUTSIDE:	Key locks & unlocks both handles
INSIDE:	Turn Button locks & unlocks both handles

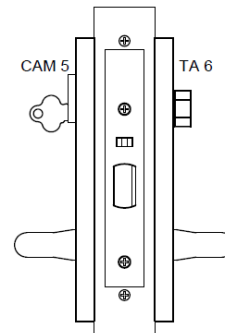

GLASS DOOR

PRODUCT CODE	DESCRIPTION
11222	Glass Door Lock

FUNCTION

OUTSIDE:	Key locks & unlocks both handles
INSIDE:	Key locks & unlocks both handles

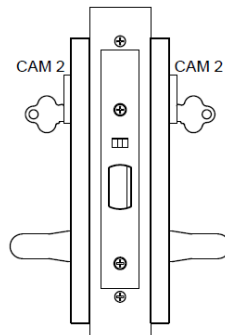

PATIO DOOR

Product Code	Description
11206	Patio Door Lock

FUNCTION

OUTSIDE:	Outside handle operates when unlocked from the inside
INSIDE:	Turn Button locks & unlocks both handles

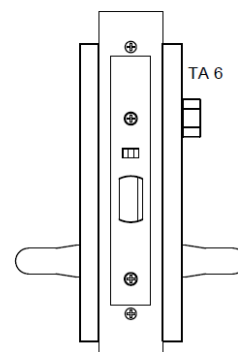

PASSAGE DOOR

PRODUCT CODE	DESCRIPTION
11200	Passage Door Latch

FUNCTION

OUTSIDE:	Handle retracts the latchbolt
INSIDE:	Handle retracts the latchbolt

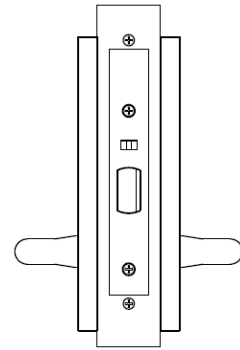

Product Code	Description	Finish
Vestibule Functions		
11116	Entrance / Office Door Lock	SSS, BLK
11156	Entrance Door Lock	SSS, BLK
11110	Storeroom Door Lock	SSS, BLK
11120	Classroom / Office Door Lock	SSS, BLK
11102	Exit Door Lock	SSS, BLK
11106	Exit Door Lock	SSS, BLK
11100	Exit Door Latch	SSS, BLK
Combination Functions		
11216	Entrance / Office Door Lock	SSS, BLK
11256	Entrance Door Lock	SSS, BLK
11222	Glass Door Lock	SSS, BLK
11206	Patio Door Lock	SSS, BLK
11200	Passage Door Latch	SSS, BLK

11000 series Lock & 4000 series Door Furniture Kits

1127-01 ENTRANCE / OFFICE DOOR LOCK & DOOR FURNITURE KIT

LOCK FUNCTION:

OUTSIDE:

Key retracts latchbolt

INSIDE:

Turn Button locks & unlocks outside handle
Inside handle free at all times

Kit inclusions:

11116 Entrance / Office Door Lock
P4127 External Plate Cylinder & Lever 27
P4627 Internal Plate Turn Button & Lever 27

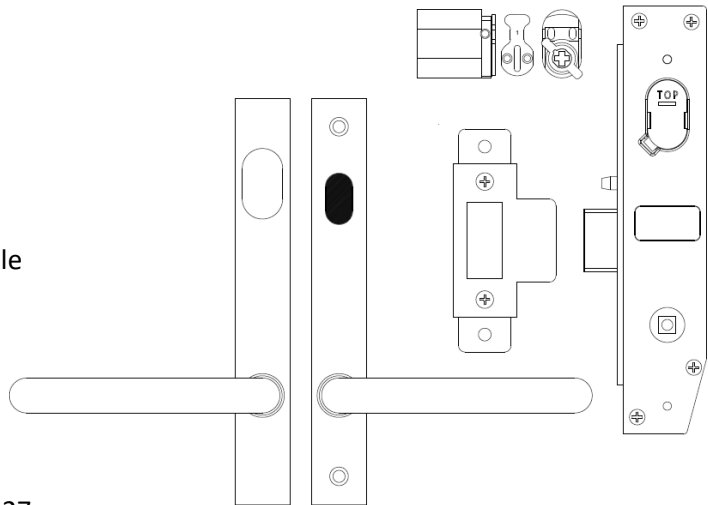

1127-02 ENTRANCE DOOR LOCK & DOOR FURNITURE KIT

LOCK FUNCTION

OUTSIDE:

Key locks & unlock outside handle

INSIDE:

Turn Button locks & unlocks outside handle
Inside handle free at all times

Kit inclusions:

11156 Entrance / Office Door Lock
P4127 External Plate Cylinder & Lever 27
P4627 Internal Plate Turn Button & Lever 27

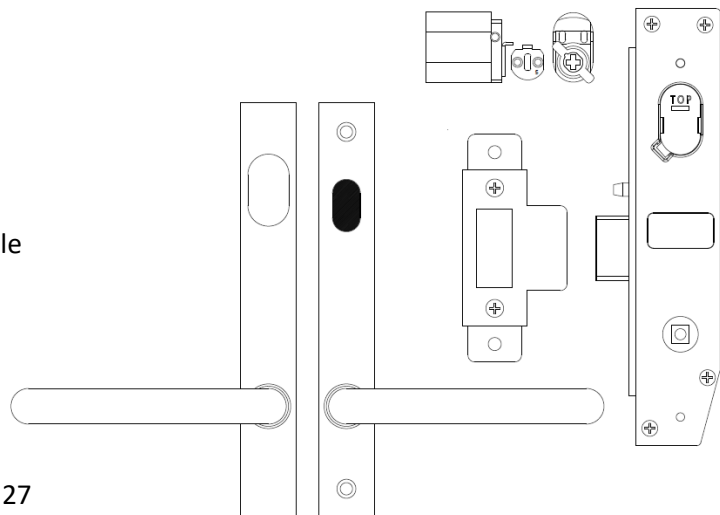

1127-03 GLASS DOOR LOCK & DOOR FURNITURE KIT

LOCK FUNCTION

OUTSIDE:

Key locks & unlocks both handles

INSIDE:

Key locks & unlocks both handles

Kit inclusions:

11222 Glass Door Lock
P4127 External Plate Cylinder & Lever 27
P4227 Internal Plate Cylinder & Lever 27

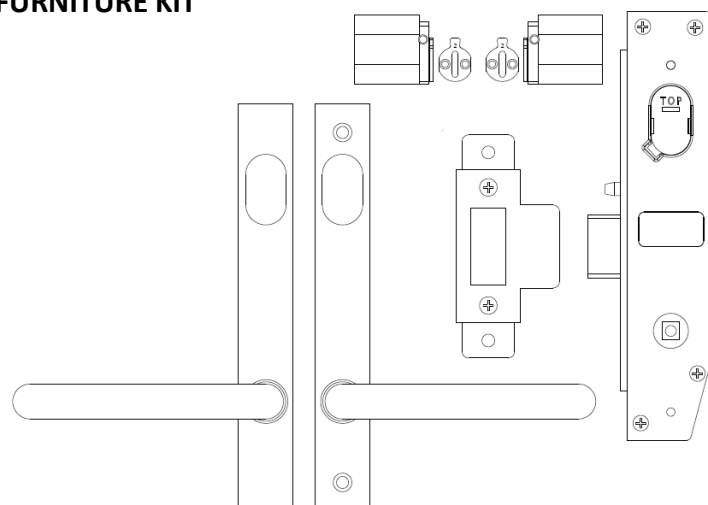

1127-04 STOREROOM DOOR LOCK & DOOR FURNITURE

LOCK FUNCTION

OUTSIDE:

Key retracts the latchbolt
Outside handle inoperative

INSIDE:

Inside handle free at all times

Kit inclusions:

11110 Storeroom Door Lock
P4127 External Plate Cylinder & Lever 27
P4427 Internal Plate Plain & Lever 27

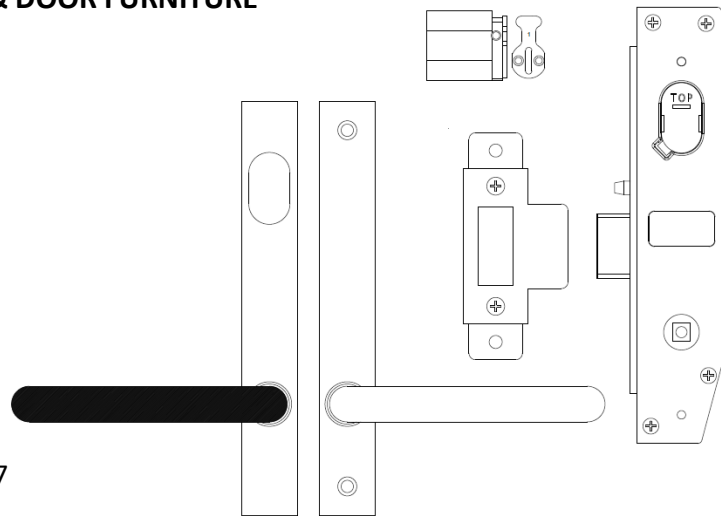

1127-05 CLASSROOM DOOR LOCK & DOOR FURNITURE

LOCK FUNCTION

OUTSIDE:

Key locks & unlocks outside handle

INSIDE:

Inside handle free at all times

Kit inclusions:

11120 Classroom / Office Door Lock
P4127 External Plate Cylinder & Lever 27
P4427 Internal Plate Plain & Lever 27

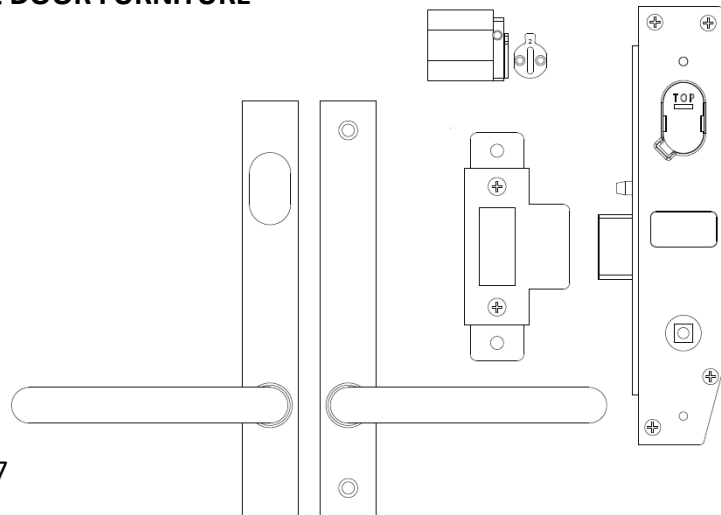

1127-06 EXTERIOR ESCAPE DOOR LOCK & DOOR FURNITURE

LOCK FUNCTION

OUTSIDE:

Key retracts the latchbolt
Outside handle locked or unlocked by
Key inside

INSIDE:

Key locks & unlocks outside handle
Inside handle free at all times

Kit inclusions:

11112 Exterior Escape Door Lock
P4127 External Plate Cylinder & Lever 27
P4227 Internal Plate Cylinder & Lever 27

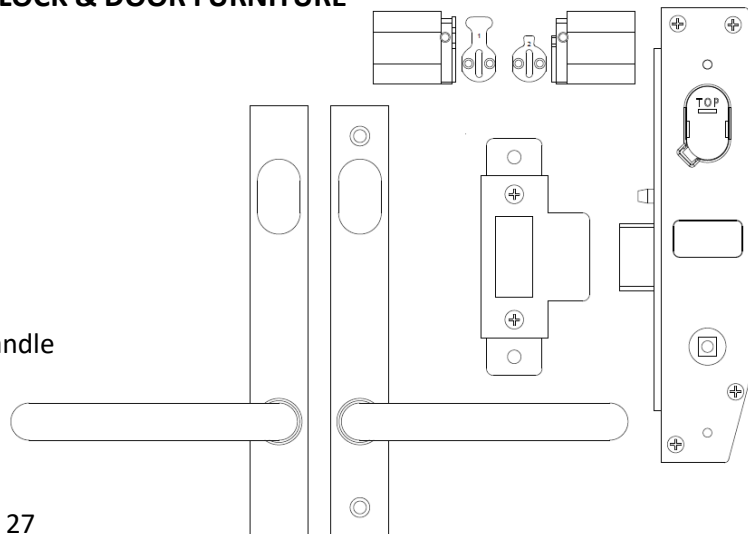

1127-07 PASSAGE DOOR LATCH & DOOR FURNITURE KIT

LOCK FUNCTION

OUTSIDE:

Handle retracts the latchbolt

INSIDE:

Handle retracts the latchbolt

Kit inclusions:

- 11200 Passage Door Latch
- P4127 External Plate Cylinder & Lever 27
- P4227 Internal Plate Cylinder & Lever 27

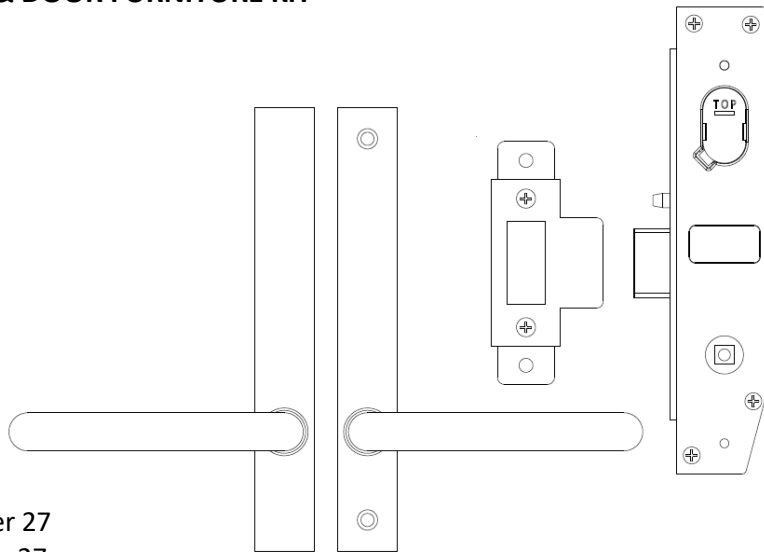

1127-08 EXIT DOOR LOCK & DOOR FURNITURE KIT

LOCK FUNCTION

OUTSIDE:

Key retracts the latchbolt
No external handle

INSIDE:

Inside handle free at all times

Kit inclusions:

- 11110 Storeroom Door Lock
- P4002 External Plate Cylinder hole only
- P4427 Internal Plate Plain & Lever 27

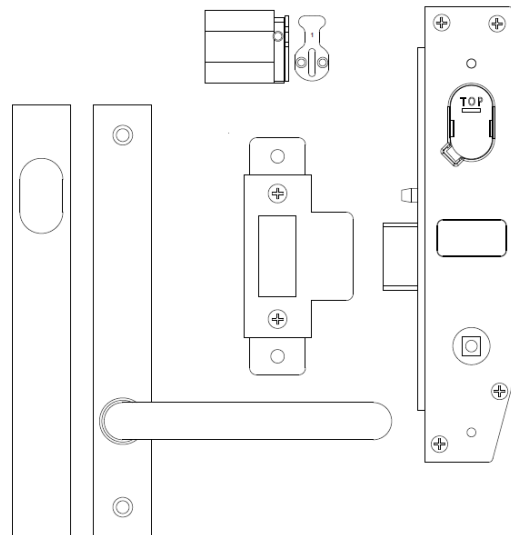

Product Code	Description	Finish
1127-01	Entrance Door Lock & Door Furniture Kit	SSS, BLK
1127-02	Office Door Lock & Door Furniture Kit	SSS, BLK
1127-03	Glass Door Lock & Door Furniture Kit	SSS, BLK
1127-04	Storeroom Door Lock & Door Furniture Kit	SSS, BLK
1127-05	Classroom Door Lock & Door Furniture Kit	SSS, BLK
1127-06	Exterior Door Lock & Door Furniture Kit	SSS, BLK
1127-07	Passage Latch & Door Furniture Kit	SSS, BLK
1127-08	Exterior Exit Door Lock & Door Furniture Kit	SSS, BLK

1127-156LC ENTRANCE DOOR LOCK & DOOR FURNITURE KIT LESS CYLINDER

Kit inclusions:

- 11000 Primary Vestibule/Combination Lock
- CML-CAM1 #1 Cylinder Cam
- CML-CAM5 #5 Cylinder Cam
- CML-TA6 #6 Turn Adaptor
- P4127 External Plate Cylinder & Lever 27
- P4627 Internal Plate Turn Button & Lever 27

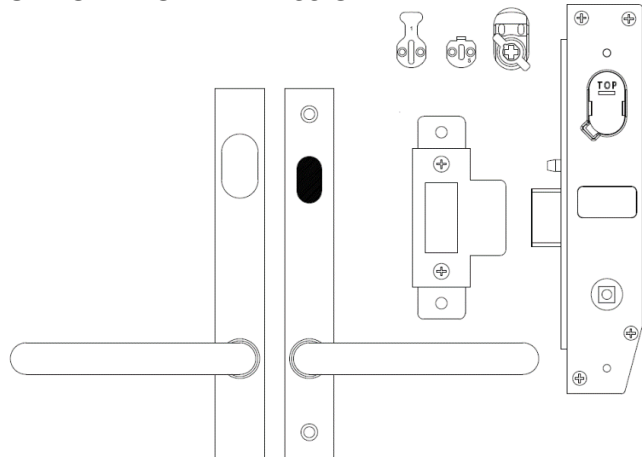

1127-22LC DOUBLE CYLINDER LOCK & DOOR FURNITURE KIT LESS CYLINDER

Kit inclusions:

- 11000 Primary Vestibule/Combination Lock
- 2 x CML-CAM2 #2 Cylinder Cam
- CML-CAM1 #1 Cylinder Cam
- P4127 External Plate Cylinder & Lever 27
- P4227 Internal Plate Cylinder & Lever 27

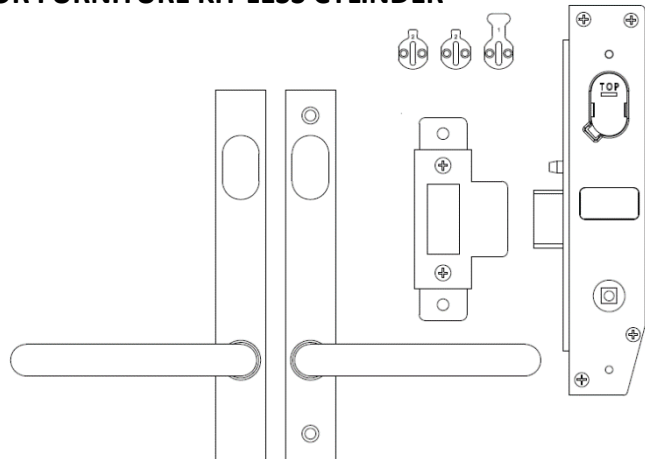

1127-12LC SINGLE CYLINDER LOCK & DOOR FURNITURE KIT LESS CYLINDER

Kit inclusions:

- 11000 Primary Vestibule/Combination Lock
- CML-CAM1 #1 Cylinder Cam
- CML-CAM2 #2 Cylinder Cam
- P4127 External Plate Cylinder & Lever 27
- P4427 Internal Plate Plain & Lever 27

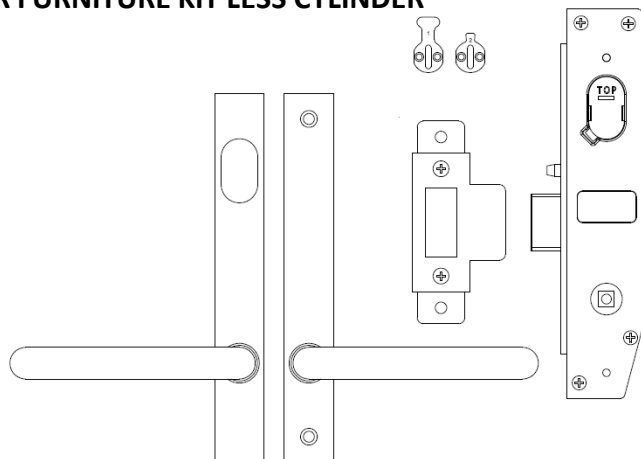

Product Code	Description	Finish
1127-156LC	Single Cylinder & Turn Lock + Door Furniture Kit (Less Cyl)	SSS, BLK
1127-22LC	Double Cylinder Lock & Door Furniture Kit (Less Cyl)	SSS, BLK
1127-12LC	Single Cylinder Lock & Door Furniture Kit (Less Cyl)	SSS, BLK

2.3: 12000 Series Narrow Stile Commercial Mortice Locks

The McCallum 12000 Series commercial mortice locks have been manufactured to meet the requirements of the Australian market. Using high quality materials to meet the durability and strength required for use in the commercial, industrial building and fabrication swing door market.

The 12000 series locks are multi-functional allowing simple switching between vestibule and combination locking functions by an external operation prior to installation.



SPECIFICATION

Lock Case:

Material high purity zinc alloy

Face Plate:

Stainless Steel 304 grade

Strike Plate:

Stainless Steel 304 grade Universal "T"-strike plate

Backset:

12000 series 30mm backset

Door Thickness:

32 - 50mm

Latchbolt:

Stainless Steel 15mm projection

Auxiliary bolt:

Stainless Steel activates dead latching.

Handing:

Reversible latchbolt (non-handed)

Spindle Hub:

Accepts standard 7.6 x 7.6mm spindles.

Cylinder:

Oval Brass outer Cylinder and inner Barrel
C4-6 Pin Standard Keyway

Cylinder retention:

Threaded retaining screw.

Operation:

Multi-functional lock body allowing for simple switching from combination to vestibule lock functions.

Durability:

12000 Series Commercial Mortice Locks conform with level D8 (Durability) Australian Lock Standard (AS 4145.2-2008).

Security:

12000 Series Commercial Mortice Locks conform with level S5 (Physical Security) Australian Lock Standard (AS 4145.2-2008).

Electric Strikes:

The 12000 Series Commercial Mortice Locks are compatible with most electric strikes.

Warranty:

10 Year mechanical

Finishes:

SSS: Satin Stainless Steel
BLK: Black

12000 series Lock Dimensions

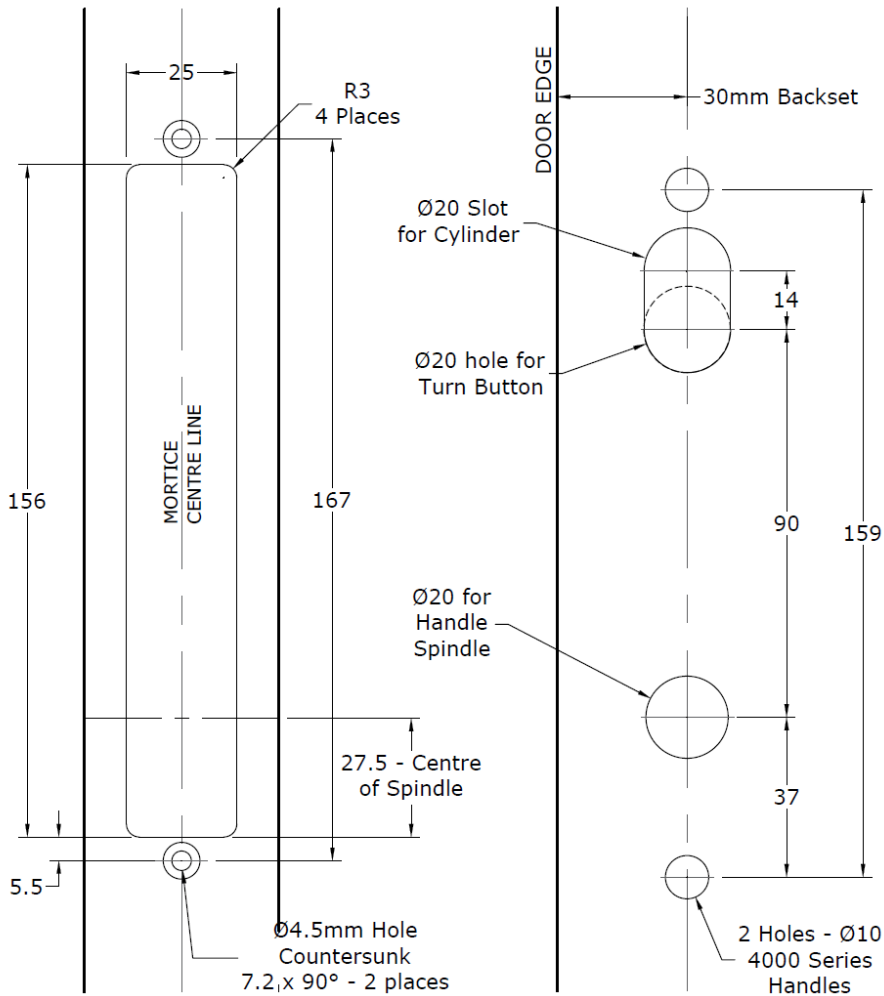
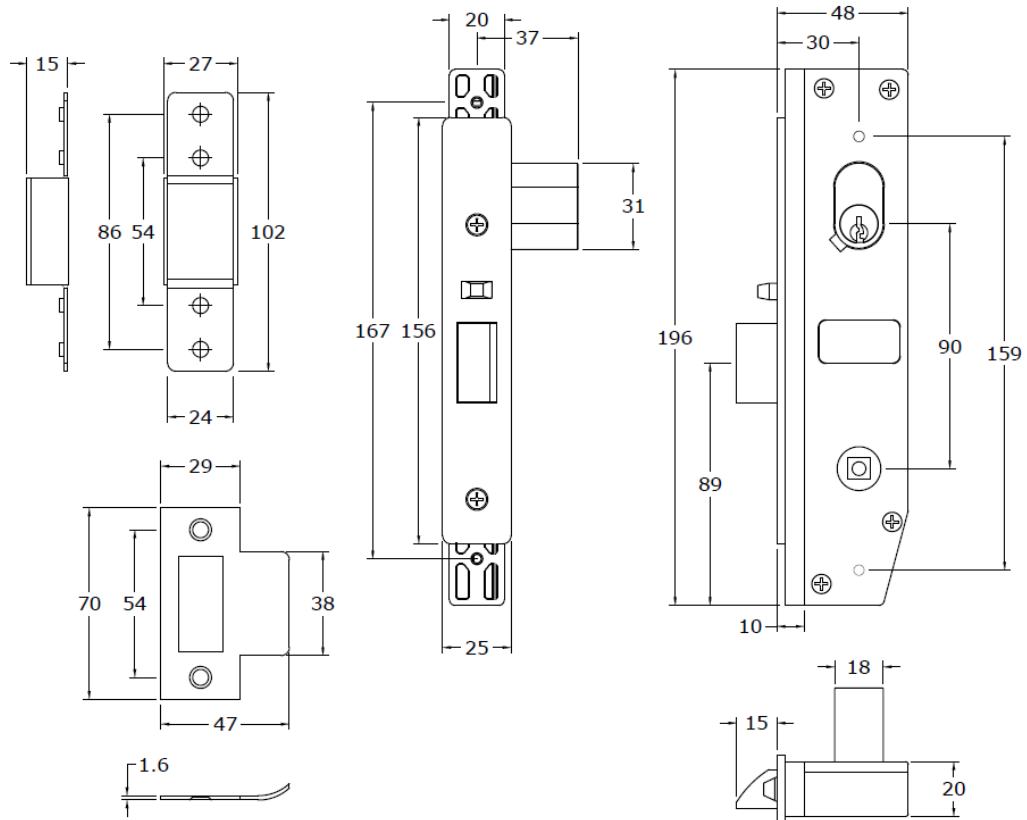

12100 Vestibule Function

ENTRANCE / OFFICE DOOR

PRODUCT CODE	DESCRIPTION
12116	Entrance / Office Door Lock

FUNCTION

OUTSIDE:	Key retracts latchbolt
INSIDE:	Turn Button locks & unlocks the outside handle Inside handle free at all times

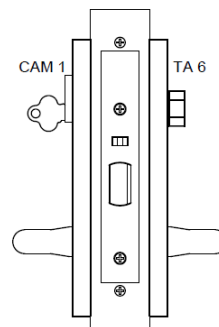

ENTRANCE DOOR

PRODUCT CODE	DESCRIPTION
12156	Entrance Door Lock

FUNCTION

OUTSIDE:	Key locks & unlock outside handle
INSIDE:	Turn Button locks & unlocks outside handle Inside handle free at all times

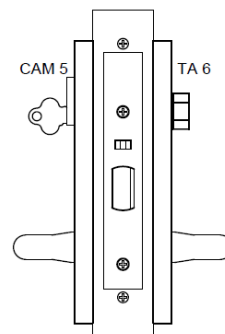

STOREROOM DOOR

PRODUCT CODE	DESCRIPTION
12110	Storeroom Door Lock

FUNCTION

OUTSIDE:	Key retracts the latchbolt outside handle inoperative
INSIDE:	Inside handle free at all times

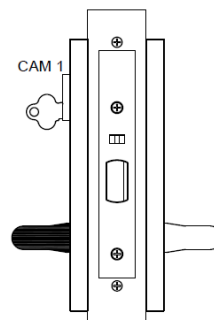

CLASSROOM / OFFICE DOOR

PRODUCT CODE	DESCRIPTION
12120	Classroom / Office Door Lock

FUNCTION

OUTSIDE:	Key locks & unlocks outside handle
INSIDE:	Inside handle free at all times

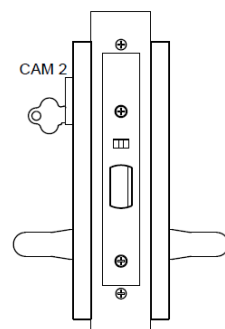

EXIT DOOR**PRODUCT CODE**

12102

DESCRIPTION

Exit Door Lock

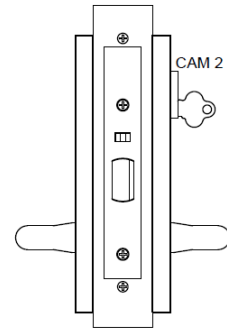
FUNCTION**OUTSIDE:** Outside handle retracts latchbolt when unlocked from the inside**INSIDE:** Key locks & unlocks outside handle
Inside handle free at all times

EXIT DOOR**PRODUCT CODE**

12106

DESCRIPTION

Exit Door Lock

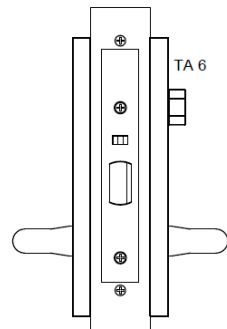
FUNCTION**OUTSIDE:** Outside handle retracts latchbolt when unlocked from the inside**INSIDE:** Turn Button locks & unlocks outside handle
Inside handle free at all times

EXIT DOOR LATCH**PRODUCT CODE**

12100

DESCRIPTION

Exit Door Lock

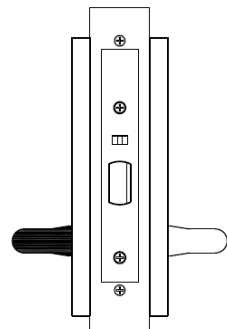
FUNCTION**OUTSIDE:** Outside handle inoperative**INSIDE:** Inside handle free at all times

12200 Combination Function

ENTRANCE / OFFICE DOOR

PRODUCT CODE	DESCRIPTION
12216	Entrance / Office Door Lock

FUNCTION

OUTSIDE:	Key retracts latchbolt
INSIDE:	Turn Button locks & unlocks both handles

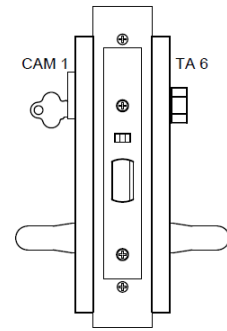

ENTRANCE DOOR

PRODUCT CODE	DESCRIPTION
12256	Entrance Door Lock

FUNCTION

OUTSIDE:	Key locks & unlocks both handles
INSIDE:	Turn Button locks & unlocks both handles

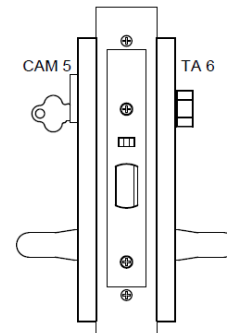

GLASS DOOR

PRODUCT CODE	DESCRIPTION
12222	Glass Door Lock

FUNCTION

OUTSIDE:	Key locks & unlocks both handles
INSIDE:	Key locks & unlocks both handles

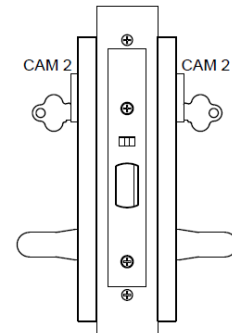

PATIO DOOR

PRODUCT CODE	DESCRIPTION
12206	Patio Door Lock

FUNCTION

OUTSIDE:	Outside handle operates when unlocked from the inside
INSIDE:	Turn Button locks & unlocks both handles

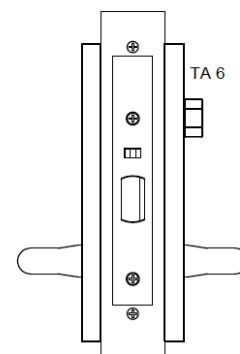

PASSAGE DOOR**PRODUCT CODE**

12200

DESCRIPTION

Passage Door Latch

FUNCTION**OUTSIDE:**

Handle retracts the latchbolt

INSIDE:

Handle retracts the latchbolt

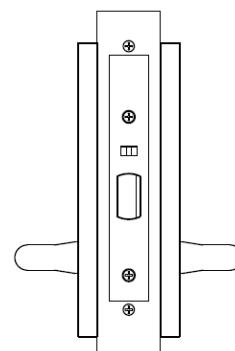

Product Code	Description	Finish
Vestibule Functions		
12116	Entrance / Office Door Lock	SSS, BLK
12156	Entrance Door Lock	SSS, BLK
12110	Storeroom Door Lock	SSS, BLK
12120	Classroom / Office Door Lock	SSS, BLK
12102	Exit Door Lock	SSS, BLK
12106	Exit Door Lock	SSS, BLK
12100	Exit Door Latch	SSS, BLK
Combination Functions		
12216	Entrance / Office Door Lock	SSS, BLK
12256	Entrance Door Lock	SSS, BLK
12222	Glass Door Lock	SSS, BLK
12206	Patio Door Lock	SSS, BLK
12200	Passage Door Latch	SSS, BLK

12000 series Lock & 4000 series Door Furniture Kits

1226-00 PASSAGE DOOR LATCH & DOOR FURNITURE KIT

Kit inclusions:

- 12000 Primary Vestibule/Combination Lock
- P4126 External Plate Cylinder & Lever 26
- P4226 Internal Plate Cylinder & Lever 26

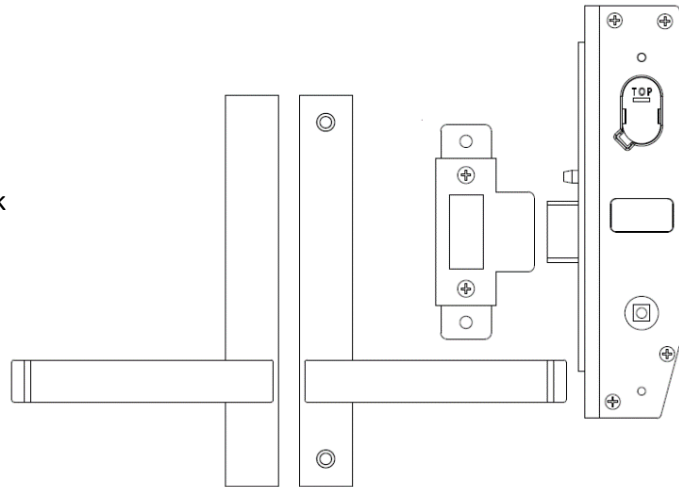

1226-01 ENTRANCE / OFFICE DOOR LOCK & DOOR FURNITURE KIT

Kit inclusions:

- 12000 Primary Vestibule/Combination Lock
- CML-OC5 Oval Cylinder #5Cam
- CML-CAM1 #1 Cylinder Cam
- CML-TA6 #6 Turn Adaptor
- P4126 External Plate Cylinder & Lever 26
- P4626 Internal Plate Turn Button & Lever 26

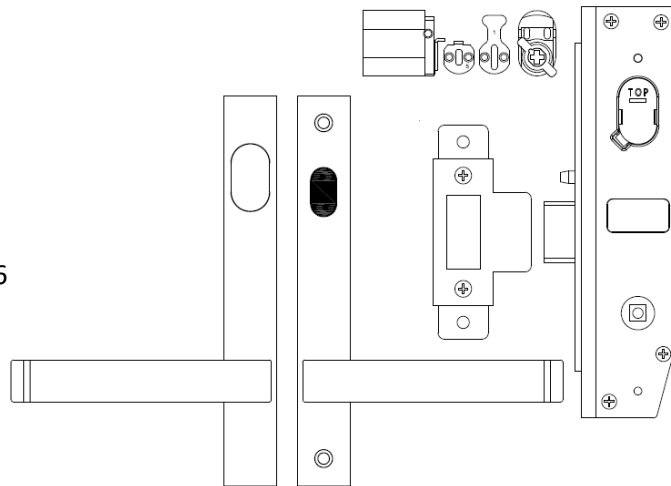

1226-02 DOUBLE CYLINDER LOCK & DOOR FURNITURE KIT

Kit inclusions:

- 12000 Primary Vestibule/Combination Lock
- CML-OC2 Oval Cylinder #2Cam x 2
- CML-CAM1 #1 Cylinder Cam
- P4126 External Plate Cylinder & Lever 26
- P4226 Internal Plate Cylinder & Lever 26

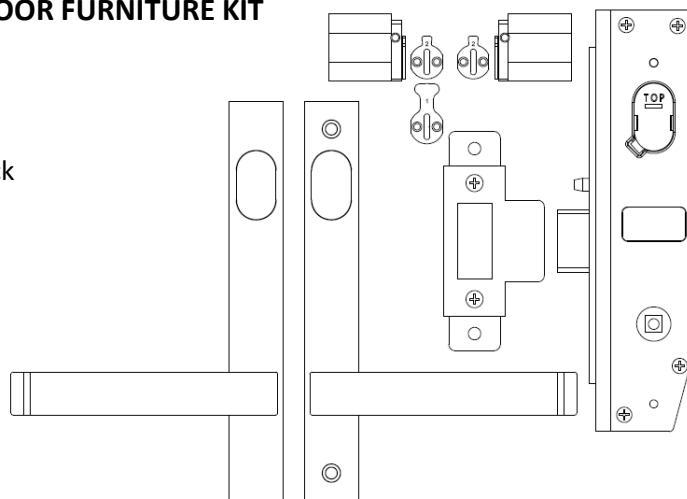

1226-03 STOREROOM/ CLASSROOM DOOR LOCK & DOOR FURNITURE

Kit inclusions:

- 12000 Primary Vestibule/Combination Lock
- CML-OC1 Oval Cylinder #1Cam
- CML-CAM2 #2 Cylinder Cam
- P4126 External Plate Cylinder & Lever 26
- P4426 Internal Plate Plain & Lever 26

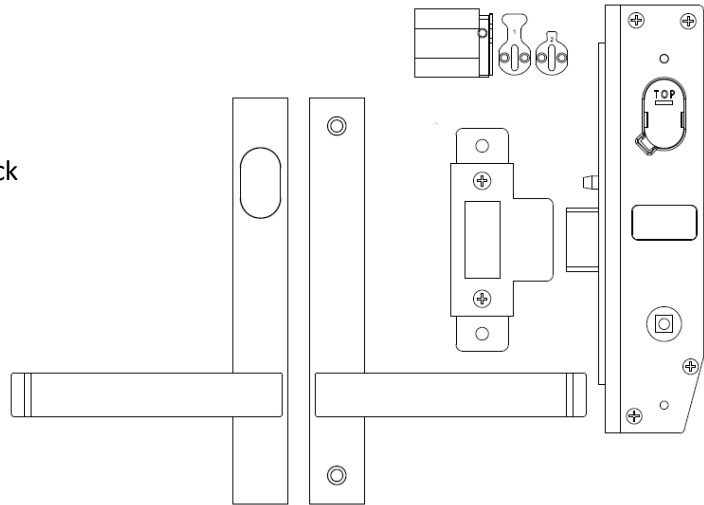

Product Code	Description	Finish
1226-00	Primary Vest/Comb Lock + Door Furniture Kit	SSS, BLK
1226-01	Single Cylinder, Turn Lock + Door Furniture Kit	SSS, BLK
1226-02	Double Cylinder Lock + Door Furniture Kit	SSS, BLK
1226-03	Single Cylinder Lock + Door Furniture Kit	SSS, BLK

1227-00 PASSAGE DOOR LATCH & DOOR FURNITURE KIT

Kit inclusions:

- 12000 Primary Vestibule/Combination Lock
- P4127 External Plate Cylinder & Lever 27
- P4227 Internal Plate Cylinder & Lever 27

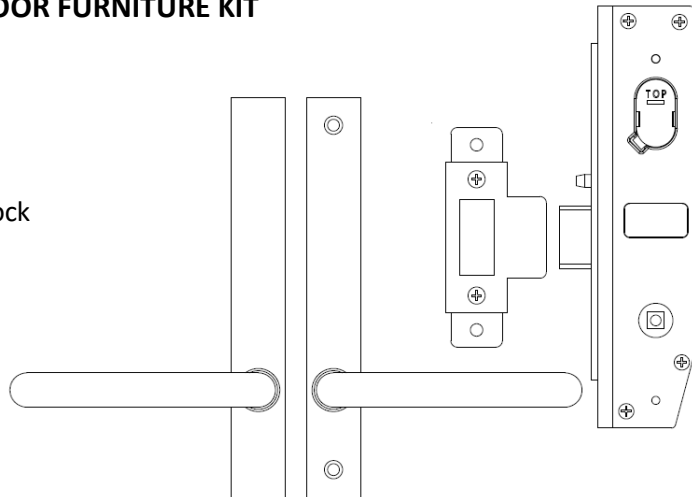

1227-01 ENTRANCE / OFFICE DOOR LOCK & DOOR FURNITURE KIT

Kit inclusions:

- 12000 Primary Vestibule/Combination Lock
- CML-OC5 Oval Cylinder #5Cam
- CML-CAM1 #1 Cylinder Cam
- CML-TA6 #6 Turn Adaptor
- P4127 External Plate Cylinder & Lever 27
- P4627 Internal Plate Turn Button & Lever 27

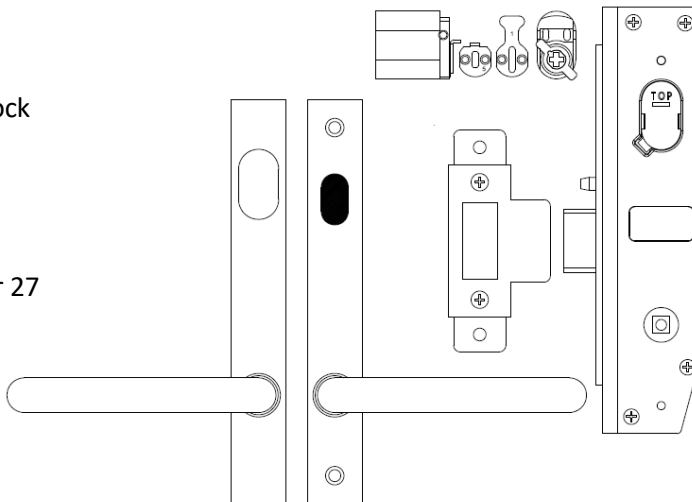

1227-02 DOUBLE CYLINDER LOCK & DOOR FURNITURE KIT

Kit inclusions:

- 12000 Primary Vestibule/Combination Lock
- CML-OC2 Oval Cylinder #2Cam x 2
- CML-CAM1 #1 Cylinder Cam
- P4127 External Plate Cylinder & Lever 27
- P4227 Internal Plate Cylinder & Lever 27

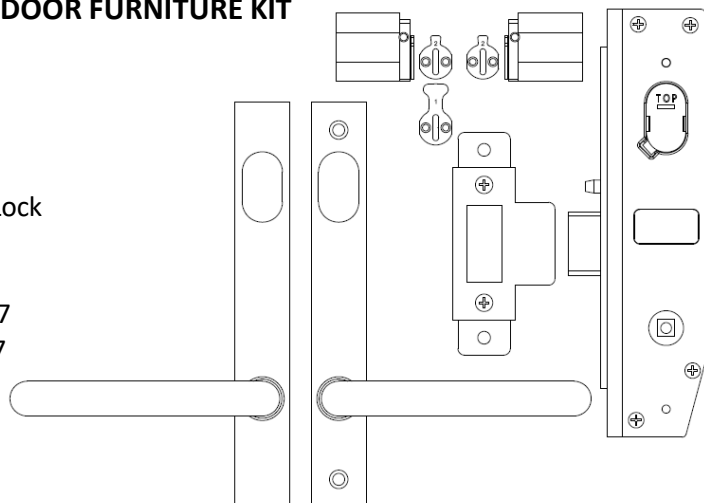

1227-03 STOREROOM/ CLASSROOM DOOR LOCK & DOOR FURNITURE

Kit inclusions:

- 12000 Primary Vestibule/Combination Lock
- CML-OC1 Oval Cylinder #1Cam
- CML-CAM2 #2 Cylinder Cam
- P4127 External Plate Cylinder & Lever 27
- P4427 Internal Plate Plain & Lever 27

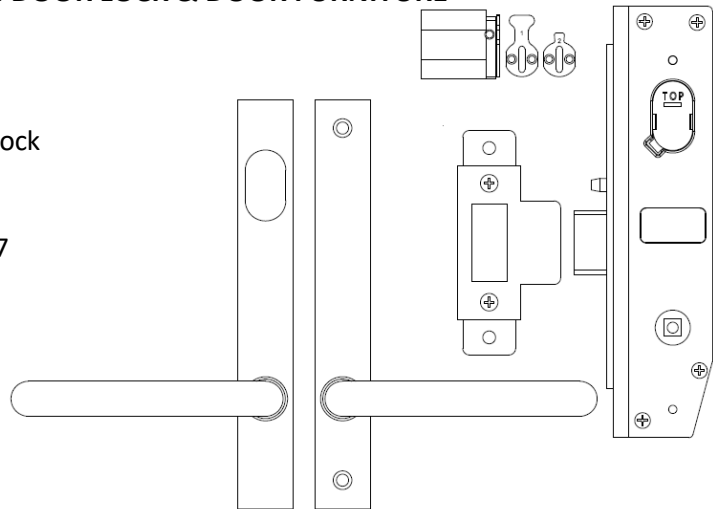

Product Code	Description	Finish
1227-00	Primary Vest/Comb Lock + Door Furniture Kit	SSS, BLK
1227-01	Single Cylinder, Turn Lock + Door Furniture Kit	SSS, BLK
1227-02	Double Cylinder Lock + Door Furniture Kit	SSS, BLK
1227-03	Single Cylinder Lock + Door Furniture Kit	SSS, BLK

1226-156LC ENTRANCE DOOR LOCK & DOOR FURNITURE KIT LESS CYLINDER

Kit inclusions:

- 12000 Primary Vestibule/Combination Lock
- CML-CAM1 #1 Cylinder Cam
- CML-CAM5 #5 Cylinder Cam
- CML-TA6 #6 Turn Adaptor
- P4126 External Plate Cylinder & Lever 26
- P4626 Internal Plate Turn Button & Lever 26

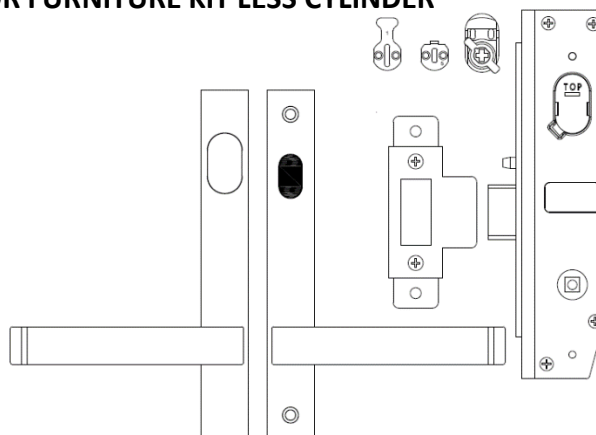

1226-22LC DOUBLE CYLINDER LOCK & DOOR FURNITURE KIT LESS CYLINDER

Kit inclusions:

- 12000 Primary Vestibule/Combination Lock
- 2 x CML-CAM2 #2 Cylinder Cam
- CML-CAM1 #1 Cylinder Cam
- P4126 External Plate Cylinder & Lever 26
- P4226 Internal Plate Cylinder & Lever 26

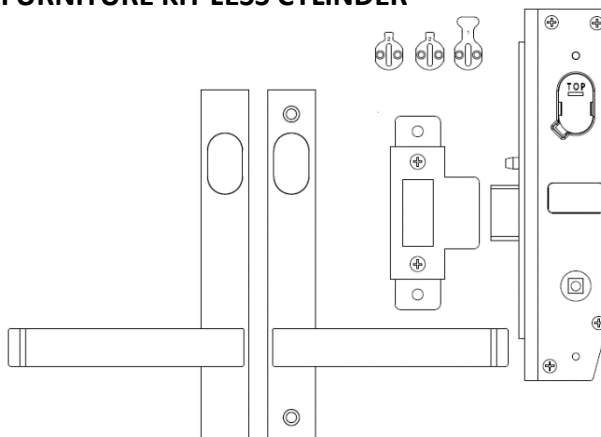

1226-12LC SINGLE CYLINDER LOCK & DOOR FURNITURE KIT LESS CYLINDER

Kit inclusions:

- 12000 Primary Vestibule/Combination Lock
- CML-CAM1 #1 Cylinder Cam
- CML-CAM2 #2 Cylinder Cam
- P4126 External Plate Cylinder & Lever 26
- P4426 Internal Plate Plain & Lever 26

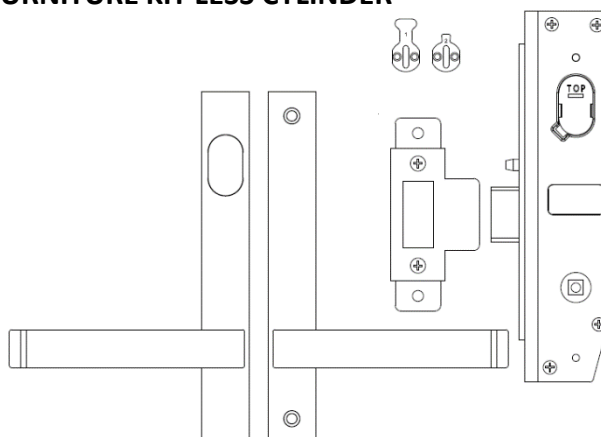

Product Code	Description	Finish
1226-156LC	Single Cylinder & Turn Lock + Door Furniture Kit (Less Cyl)	SSS, BLK
1226-22LC	Double Cylinder Lock & Door Furniture Kit (Less Cyl)	SSS, BLK
1226-12LC	Single Cylinder Lock & Door Furniture Kit (Less Cyl)	SSS, BLK

1227-156LC ENTRANCE DOOR LOCK & DOOR FURNITURE KIT LESS CYLINDER

Kit inclusions:

- 12000 Primary Vestibule/Combination Lock
- CML-CAM1 #1 Cylinder Cam
- CML-CAM5 #5 Cylinder Cam
- CML-TA6 #6 Turn Adaptor
- P4127 External Plate Cylinder & Lever 27
- P4627 Internal Plate Turn Button & Lever 27

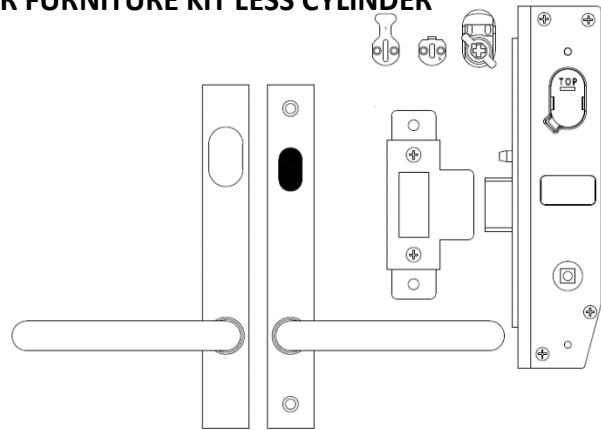

1227-22LC DOUBLE CYLINDER LOCK & DOOR FURNITURE KIT LESS CYLINDER

Kit inclusions:

- 12000 Primary Vestibule/Combination Lock
- 2 x CML-CAM2 #2 Cylinder Cam
- CML-CAM1 #1 Cylinder Cam
- P4127 External Plate Cylinder & Lever 27
- P4227 Internal Plate Cylinder & Lever 27

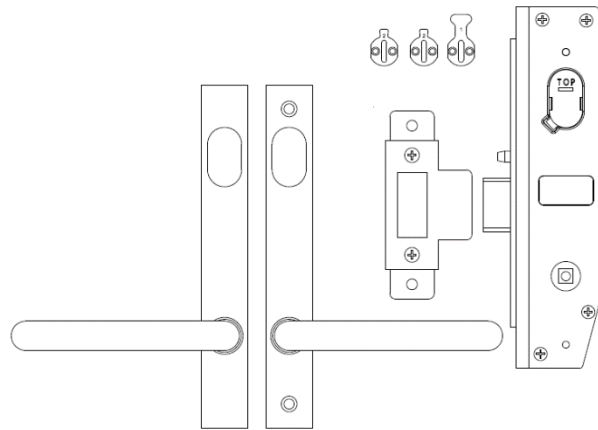

1227-12LC SINGLE CYLINDER LOCK & DOOR FURNITURE KIT LESS CYLINDER

Kit inclusions:

- 12000 Primary Vestibule/Combination Lock
- CML-CAM1 #1 Cylinder Cam
- CML-CAM2 #2 Cylinder Cam
- P4127 External Plate Cylinder & Lever 27
- P4427 Internal Plate Plain & Lever 27

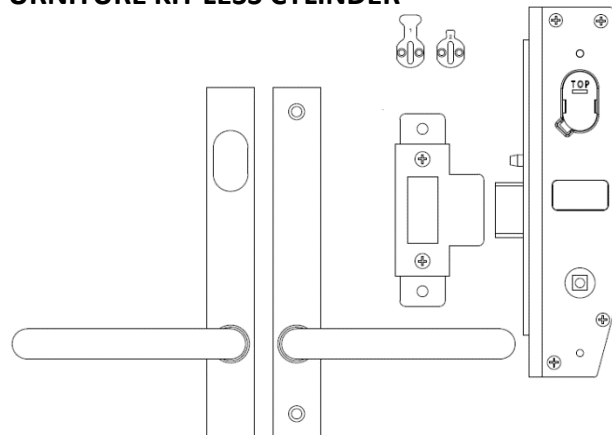

Product Code	Description	Finish
1227-156LC	Single Cylinder & Turn Lock + Door Furniture Kit (Less Cyl)	SSS, BLK
1227-22LC	Double Cylinder Lock & Door Furniture Kit (Less Cyl)	SSS, BLK
1227-12LC	Single Cylinder Lock & Door Furniture Kit (Less Cyl)	SSS, BLK

2.4: Commercial Mortice Lock Cylinders & Accessories

The McCallum Commercial Oval Cylinders are manufactured from high quality Brass outer cylinder and inner barrel.

Keyway:

Standard C4 Keyway 6 Pin tumbler



Oval Cylinders

PRODUCT CODE

CML-OC0
CML-OC1
CML-OC2
CML-OC5

DESCRIPTION

Oval Cylinder
Oval Cylinder + #1Cam
Oval Cylinder + #2Cam
Oval Cylinder + #5Cam

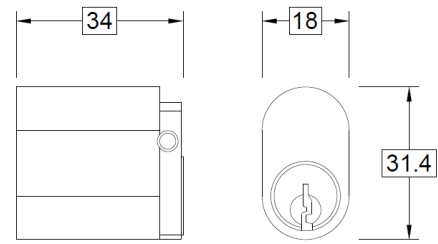

Finishes:

SC: Satin Chrome
BLK: Black



Cylinders Cams

PRODUCT CODE

CML-CAM1
CML-CAM2
CML-CAM5

DESCRIPTION

#1 Cylinder Cam
#2 Cylinder Cam
#5 Cylinder Cam

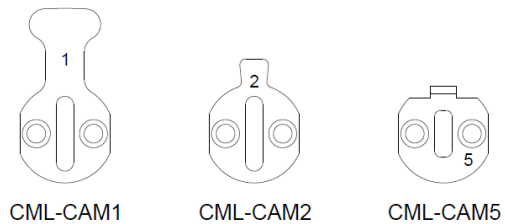

Turn Adaptors

PRODUCT CODE

CML-TA1
CML-TA6

DESCRIPTION

#1 Turn Adaptor
#6 Turn Adaptor

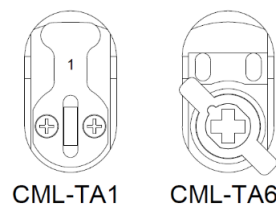

2.5: Euro Mortice Locks

The McCallum Euro Mortice Lock range is available in 30mm backset making it suitable for residential and light commercial aluminium/metal and timber doors. Accompanied by the McCallum Euro cylinder range, 5500 series Euro long plate door furniture offering designer locking solutions to suit residential applications.

Euro Cylinder – Fixed cam available as Double, Single & Turn and Single Cylinder in various lengths to suit door different thickness.

Cylinder sold separately to suit the requirement.

Finishes:

SSS: Satin Stainless Steel

BLK: Black

PSS: Polished Stainless Steel



EML30 Euro Mortice Lock

SPECIFICATION

- Backset:** 30mm
- Pitch:** 85mm
- Door Thickness:** 32mm - 45mm
- Latchbolt:**
Stainless Steel - 12mm projection Reversible
(Non-Handed)
- Deadbolt:**
Stainless Steel – single throw - 15mm projection
- Spindle Hub:**
Accepts 7.6 & 8mm spindles
- Face Plate:**
Stainless Steel
- Strike Plate:**
Stainless Steel – 2mm reversible Nylon Strike box
- Key Operation:**
The key will lock and unlock the double throw deadbolt as well as retract latchbolt for single hand operation.

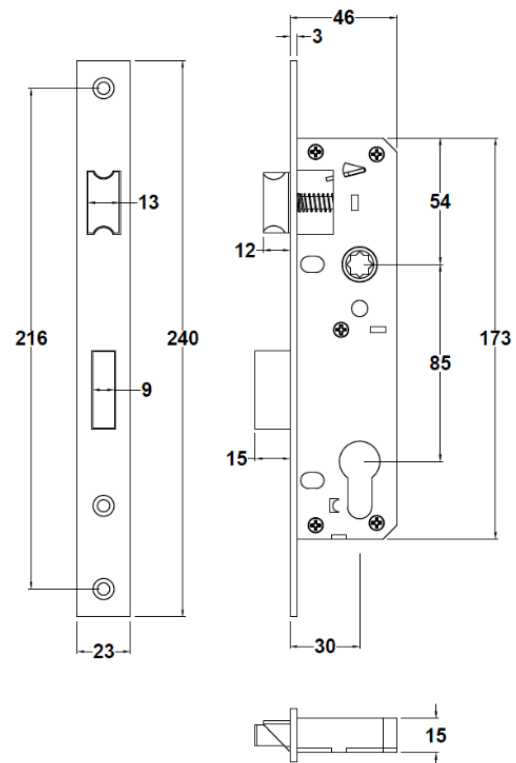

Product Code	Description	Finish
EML30LC	Euro Mortice Lock 85 x 30mm Less Cylinder	SSS, BLK

2.6: Euro Cylinders

The McCallum Euro cylinder range are manufactured from high quality machine finished Brass outer cylinder and inner barrel.

The Fixed cam cylinder has been designed to enable a key to enter and activate the cylinder with a key inserted on the opposing side.

Keyway:

Standard C4 profile 5 Pin tumbler.

Finishes:

SC: Satin Chrome

BLK: Black

CP: Chrome Plate



ECYL01 Euro Double Cylinder C4-5Pin 65mm

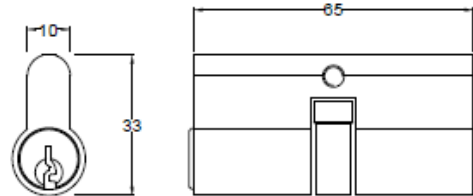

ECYL02 Euro Double Cylinder C4-5Pin 70mm

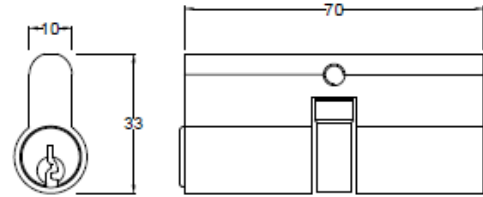

ECYL03 Euro Double Cylinder C4-5Pin 80mm

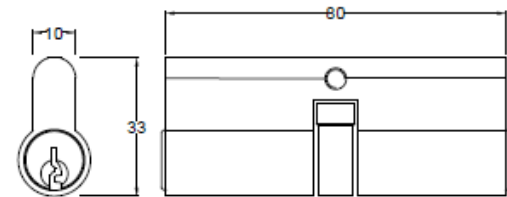

ECYL04 Euro Cylinder & Turn C4-5Pin 65mm

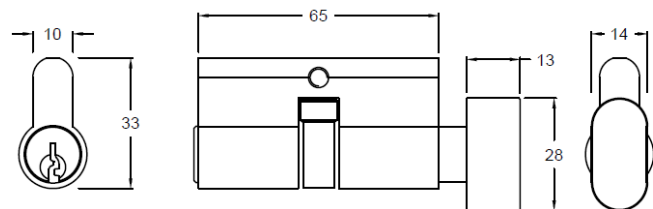

ECYL05 Euro Cylinder & Turn C4-5Pin 70mm

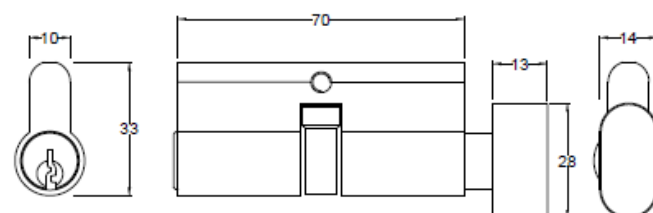

ECYL06 Euro Single Cylinder C4-5Pin 45mm

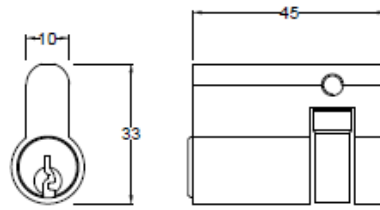

ECYL07 Euro Cylinder & Turn C4-5Pin 80mm

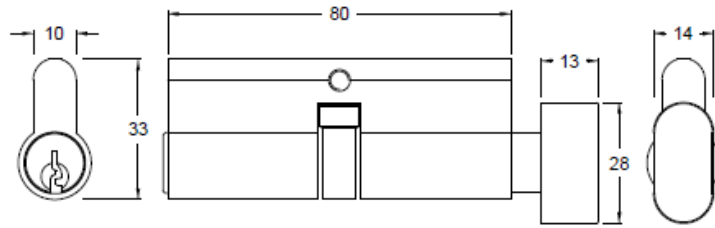

Product Code	Description	Finish
ECYL01	Euro Double Cylinder Dual Function C4-5 Pin 65mm	SC, BLK
ECYL02	Euro Double Cylinder Dual Function C4-5 Pin 70mm	SC, BLK
ECYL03	Euro Double Cylinder Dual Function C4-5 Pin 80mm	SC, BLK
ECYL04	Euro Single Cylinder & Turn C4-5 Pin 65mm	SC, BLK
ECYL05	Euro Single Cylinder & Turn C4-5 Pin 70mm	SC, BLK
ECYL06	Euro Single Cylinder C4-5 Pin 45mm	SC, BLK
ECYL07	Euro Single Cylinder & Turn C4-5 Pin 80mm	SC, BLK

3: Door Furniture



3.1: 3000 Series Long Plate Door Furniture



The 3000 series long plate door furniture has primarily been designed for use with the 10000 series commercial mortice locks.

Manufactured from high quality Stainless Steel that meets the strength and durability required for use in the Australian commercial and industrial building market, suitable for both external and internal door.

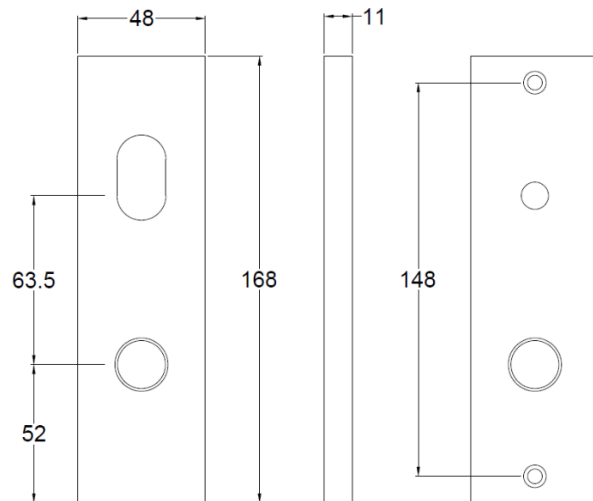

SPECIFICATION

Lever/handle:

Solid investment cast 304 grade Stainless Steel machine finished.

Plate:

Solid investment cast 304 grade Stainless Steel machine finished.

Plate Dimensions:

168 x 48 x 11mm

Door Thickness:

32 - 45mm

Fixing:

Back-to-back through door fixing screws M4x65mm.

Spindle:

7.6mm standard spindle

Handing:

Reversible (non-handed)

Durability:

3000 Series Door Furniture conforms with level D8 (Durability) Australian Lock Standard (AS 4145.2-2008).



Fire Rated:

Successfully tested in accordance with Australian Lock Standard (AS 1905.1-2015).



AS1428.1 Compliance

The 3000 series includes levers that are AS1428.1 compliant.

Warranty:

10 Year mechanical

Finishes:

SSS: Satin Stainless Steel

BLK: Black

EXTERNAL PLATES

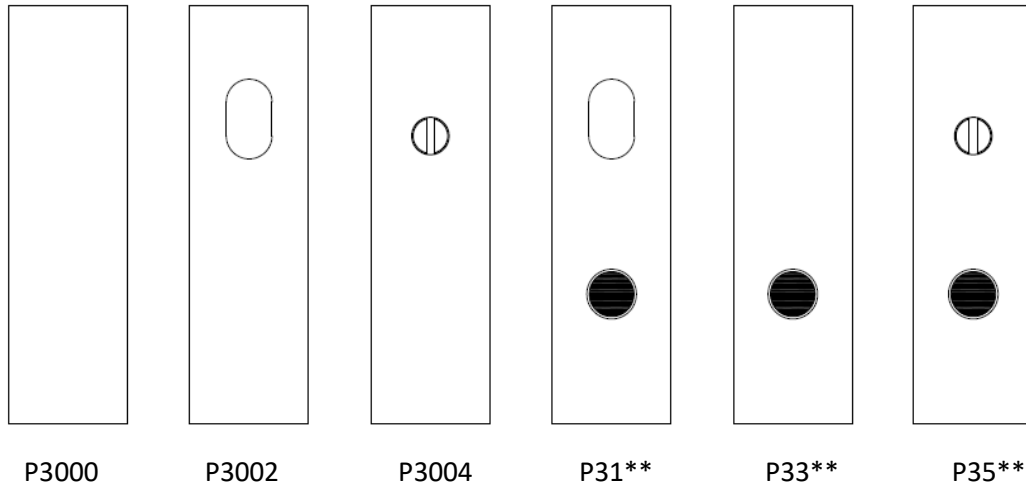

NOTE: for complete product code replace ** with lever number eg P3212

INTERNAL PLATES

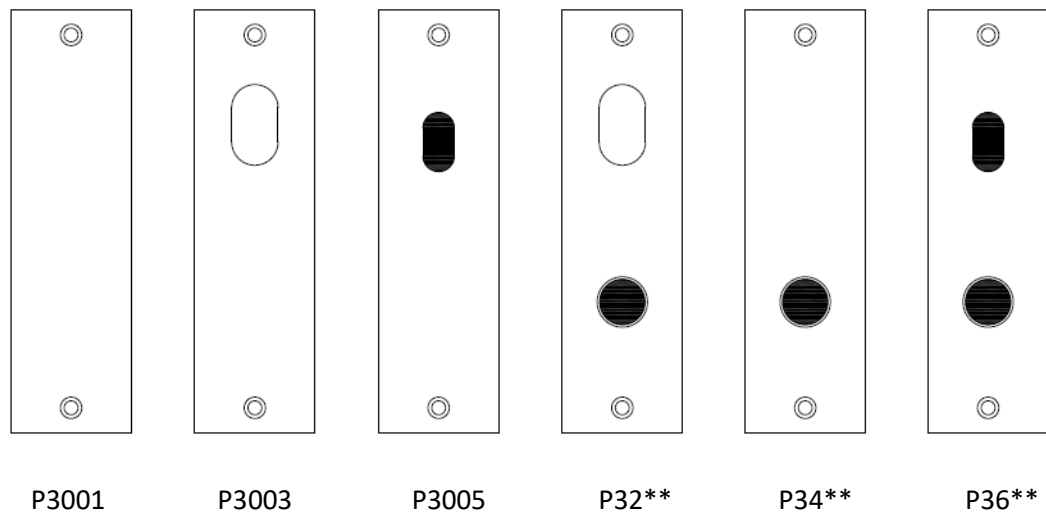

NOTE: for complete product code replace ** with lever number eg P3212

PLATE LEGEND

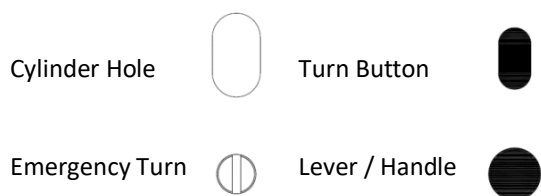

LEVERS

Lever 26

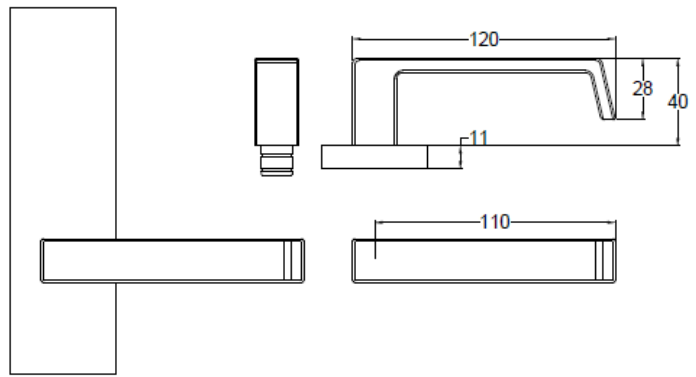

Fire Rated



Lever 27

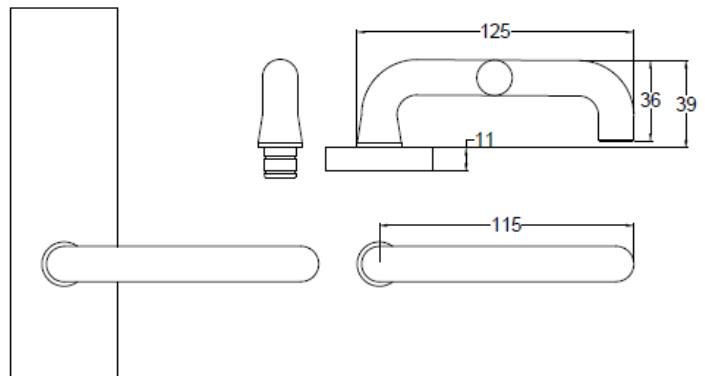

Fire Rated



Product Code	Description	Finish
P3000	External Plate Plain	SSS, BLK
P3001	Internal Plate Plain	SSS, BLK
P3002	External Plate Cylinder only	SSS, BLK
P3003	Internal Plate Cylinder only	SSS, BLK
P3126	External Plate Cylinder & Lever 26	SSS, BLK
P3127	External Plate Cylinder & Lever 27	SSS, BLK
P3226	Internal Plate Cylinder & Lever 26	SSS, BLK
P3227	Internal Plate Cylinder & Lever 27	SSS, BLK
P3326	External Plate Plain & Lever 26	SSS, BLK
P3327	External Plate Plain & Lever 27	SSS, BLK
P3426	Internal Plate Plain & Lever 26	SSS, BLK
P3427	Internal Plate Plain & Lever 27	SSS, BLK
P3526	External Plate Emergency Release & Lever 26	SSS, BLK
P3527	External Plate Emergency Release & Lever 27	SSS, BLK
P3626	Internal Plate Turn Button & Lever 26	SSS, BLK
P3627	Internal Plate Turn Button & Lever 27	SSS, BLK

3.2: 4000 Series Narrow Stile Long Plate Door Furniture



The 4000 series square end long plate door furniture has been designed for use with the 11000 series narrow stile commercial mortice locks.

Manufactured from high quality Stainless Steel that meets the strength and durability required for use in the Australian commercial, industrial and fabrication door market, suitable for both external and internal door.

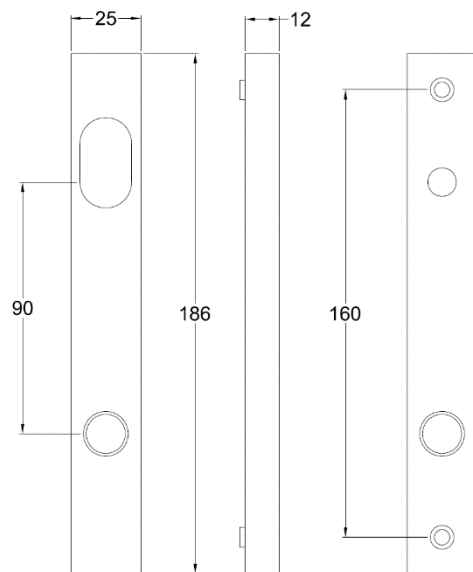

SPECIFICATION

Lever/handle:

Solid investment cast 304 grade Stainless Steel machine finished.

Plate:

Solid investment cast 304 grade Stainless Steel machine finished.

Plate Dimensions:

186 x 25 x 12mm

Door Thickness:

32 - 50mm

Fixing:

Back-to-back through door fixing, 2 x screws M4x65mm.

Spindle:

7.6mm standard spindle x 2

Handing:

Reversible (non-handed) Lever handing is as simple as rotating the levers 180°.

Durability:

4000 Series Door Furniture conforms with level D8 (Durability) Australian Lock Standard (AS 4145.2-2008).



AS1428.1 Compliance

The 4000 series includes levers that are AS1428.1 compliant.

Warranty:

10 Year mechanical

Finishes:

SSS: Satin Stainless Steel

BLK: Black

EXTERNAL PLATES



P4000



P4002



P41**



P43**



P45**

NOTE: for complete product code replace ** with lever number eg P4127

INTERNAL PLATES



P4001

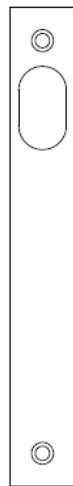

P4003



P4005



P42**



P44**



P46**

NOTE: for complete product code replace ** with lever number eg P4227

PLATE LEGEND

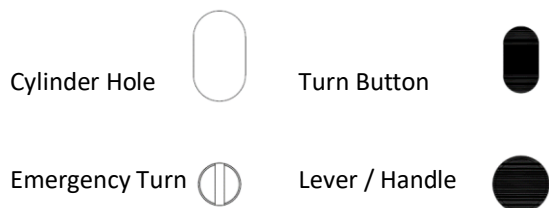

LEVERS

Lever 26

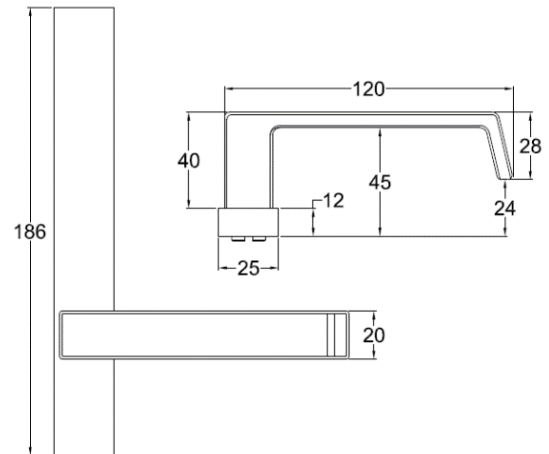

Lever 27

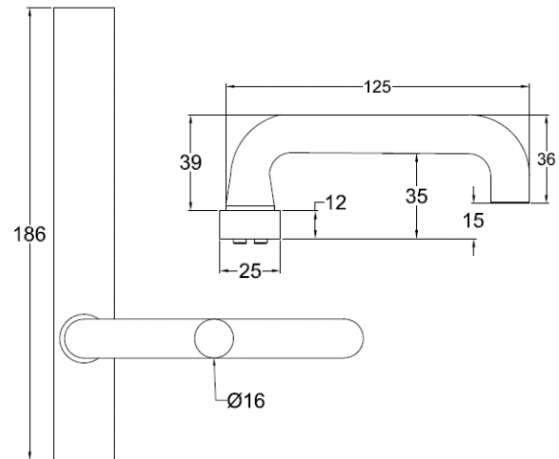

Product Code	Description	Finish
P4000	External Plate Plain	SSS, BLK
P4001	Internal Plate Plain	SSS, BLK
P4002	External Plate Cylinder only	SSS, BLK
P4003	Internal Plate Cylinder only	SSS, BLK
P4126	External Plate Cylinder & Lever 26	SSS, BLK
P4127	External Plate Cylinder & Lever 27	SSS, BLK
P4226	Internal Plate Cylinder & Lever 26	SSS, BLK
P4226	Internal Plate Cylinder & Lever 26	SSS, BLK
P4326	External Plate Plain & Lever 26	SSS, BLK
P4327	External Plate Plain & Lever 27	SSS, BLK
P4426	Internal Plate Plain & Lever 26	SSS, BLK
P4427	Internal Plate Plain & Lever 27	SSS, BLK
P4526	External Plate Emergency Release & Lever 26	SSS, BLK
P4527	External Plate Emergency Release & Lever 27	SSS, BLK
P4626	Internal Plate Turn Button & Lever 26	SSS, BLK
P4627	Internal Plate Turn Button & Lever 27	SSS, BLK

4000 SERIES DOOR FURNITURE KIT PRODUCT CODES

ENTRANCE KIT

PRODUCT CODE **DESCRIPTION**
P4026-01 Entrance - Door Furniture Kit

OUTSIDE: External Plate Cylinder & Lever 26
INSIDE: Internal Plate Turn Button & Lever 26

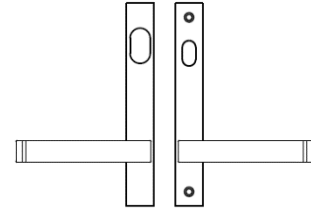

SINGLE CYLINDER KIT

PRODUCT CODE **DESCRIPTION**
P4026-02 Single Cylinder - Door Furniture Kit

OUTSIDE: External Plate Cylinder & Lever 26
INSIDE: Internal Plate Plain Lever 26

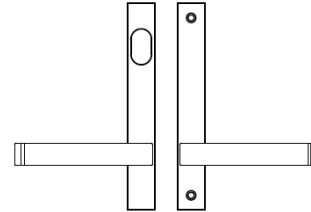

DOUBLE CYLINDER KIT

PRODUCT CODE **DESCRIPTION**
P4026-03 Double Cylinder - Door Furniture Kit

OUTSIDE: External Plate Cylinder & Lever 26
INSIDE: Internal Plate Cylinder & Lever 26

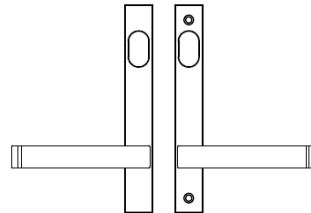

PASSAGE KIT

PRODUCT CODE **DESCRIPTION**
P4026-04 Passage - Door Furniture Kit

OUTSIDE: External Plate Plain Lever 26
INSIDE: Internal Plate Plain Lever 26

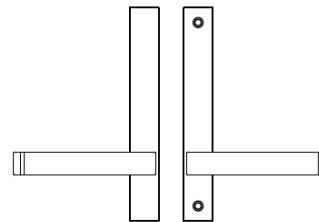

Product Code	Description	Finish
P4026-01	Entrance - Door Furniture Kit	SSS, BLK
P4026-02	Single - Cylinder Door Furniture Kit	SSS, BLK
P4026-03	Double - Cylinder Door Furniture Kit	SSS, BLK
P4026-04	Passage - Door Furniture Kit	SSS, BLK

4000 SERIES DOOR FURNITURE KIT PRODUCT CODES

ENTRANCE KIT

PRODUCT CODE **DESCRIPTION**
P4027-01 Entrance - Door Furniture Kit

OUTSIDE: External Plate Cylinder & Lever 27
INSIDE: Internal Plate Turn Button & Lever 27

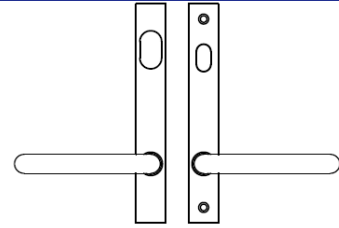

SINGLE CYLINDER KIT

PRODUCT CODE **DESCRIPTION**
P4027-02 Single Cylinder - Door Furniture Kit

OUTSIDE: External Plate Cylinder & Lever 27
INSIDE: Internal Plate Plain Lever 27

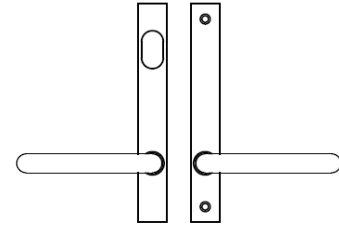

DOUBLE CYLINDER KIT

PRODUCT CODE **DESCRIPTION**
P4027-03 Double Cylinder - Door Furniture Kit

OUTSIDE: External Plate Cylinder & Lever 27
INSIDE: Internal Plate Cylinder & Lever 27

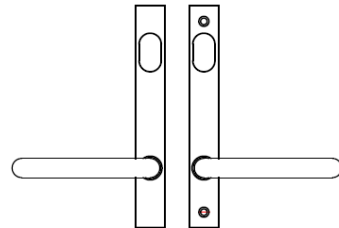

PASSAGE KIT

PRODUCT CODE **DESCRIPTION**
P4027-04 Passage - Door Furniture Kit

OUTSIDE: External Plate Plain Lever 27
INSIDE: Internal Plate Plain Lever 27

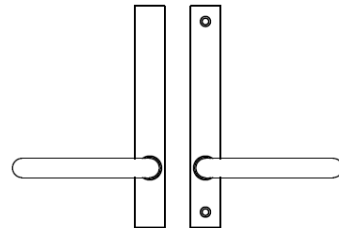

Product Code	Description	Finish
P4027-01	Entrance - Door Furniture Kit	SSS, BLK
P4027-02	Single Cylinder - Door Furniture Kit	SSS, BLK
P4027-03	Double Cylinder - Door Furniture Kit	SSS, BLK
P4027-04	Passage - Door Furniture Kit	SSS, BLK

3.3: 5000 Series Rosette Door Furniture

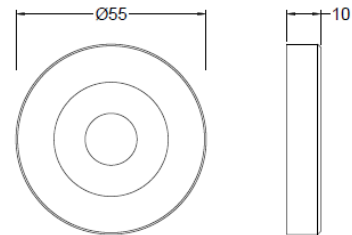

The 5000 Series Rosette door furniture has been manufactured to meet the requirements of the Australian market.

Using high quality materials to meet the strength and durability suitable for use in commercial and industrial building requirements.

Through door concealed fixing designed to suit both commercial mortice locks and common tubular latches.

Round Escutcheons & Turns to compliment the handle sets.

SPECIFICATION

Lever/handle:

Solid investment cast 304 grade Stainless Steel machine finished.

Rosette:

Stainless Steel 304 grade Round & Square Rosette

Door Thickness:

32 - 45mm

Handing:

Reversible (non-handed)

Spindle:

7.6mm standard spindle

Latches:

Privacy Latch 60mm backset inclusive in set

*Passage sets are less latch

Durability:

5000 Series Door Furniture conforms with level D8 (Durability) - Australian Lock Standard (AS 4145.2-2008).

**Fire Rated:**

Successfully tested in accordance with Australian Lock Standard (AS 1905.1-2015).

**AS1428.1 Compliance**

The 5000 series includes levers that are AS1428.1 compliant.

Warranty:

10 Year mechanical

Finishes:

SSS: Satin Stainless Steel

BLK: Black

Round Rosette

R5112 Round Rosette Passage Set

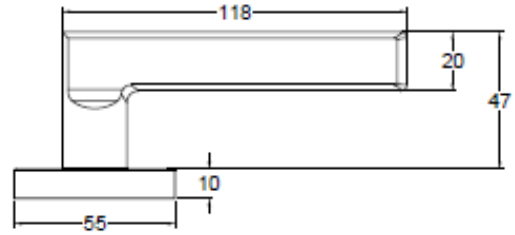

R5125 Round Rosette Passage Set

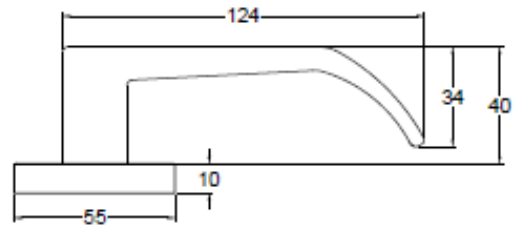

R5126 Round Rosette Passage Set

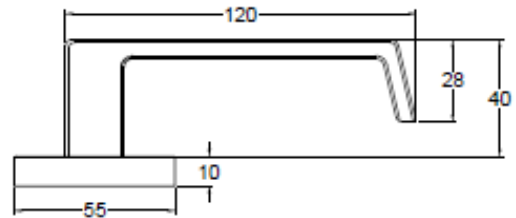

R5127 Round Rosette Passage Set

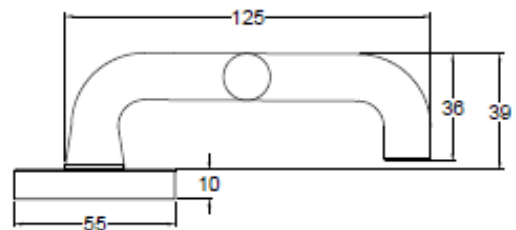

R5212 Round Rosette Privacy Set

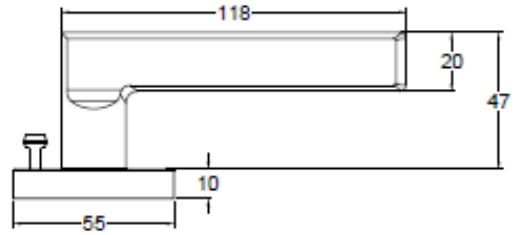

R5225 Round Rosette Privacy Set

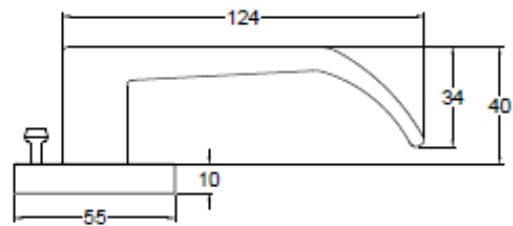

R5226 Round Rosette Privacy Set

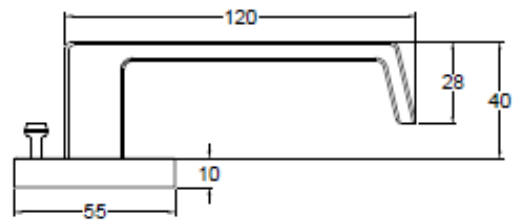

R5227 Round Rosette Privacy Set

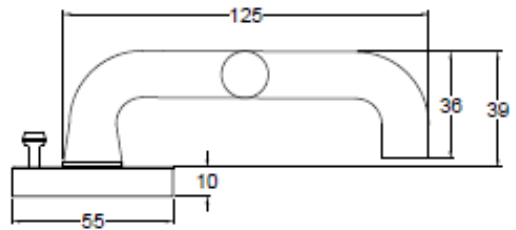

Escutcheons & Turn Buttons

R50E1 Round Oval Cylinder Escutcheon

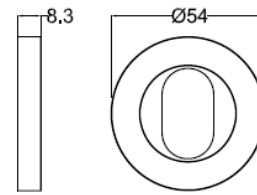

R50T3 Round Turn Button Escutcheon

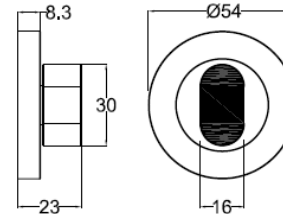

R50T4 Round Disabled Turn Escutcheon

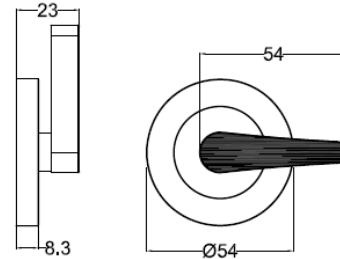
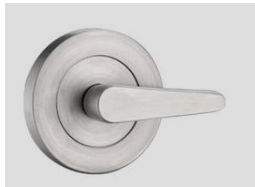

R50T5 Round Emergency Release Escutcheon

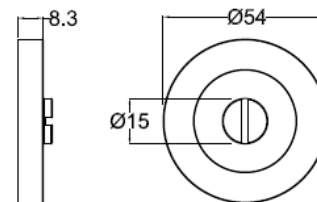

Product Code	Description	Finish
R5112	Round Rosette Passage Set (less Latch)	SSS, BLK
R5125	Round Rosette Passage Set (less Latch)	SSS, BLK
R5126	Round Rosette Passage Set (less Latch)	SSS, BLK
R5127	Round Rosette Passage Set (less Latch)	SSS, BLK
R5212	Round Rosette Privacy Set	SSS, BLK
R5225	Round Rosette Privacy Set	SSS, BLK
R5226	Round Rosette Privacy Set	SSS, BLK
R5227	Round Rosette Privacy Set	SSS, BLK
R50E1	Round Oval Cylinder Escutcheon	SSS, BLK
R50E2	Round Euro Cylinder Escutcheon	SSS, BLK
R50T4	Round Disabled Accessible Turn Escutcheon	SSS, BLK
R50T5	Round Emergency Release Escutcheon	SSS, BLK

3.4: 5500 Series Euro Long Plate Door Furniture

The 5500 series Euro long plate door furniture has been designed for use with the McCallum Euro narrow stile mortice locks.

Manufactured from high quality materials to meet the strength and durability required for use in the Australian semi-commercial and residential building market, suitable for both external and internal door.

Available in a range of functions to suit a variety of applications.

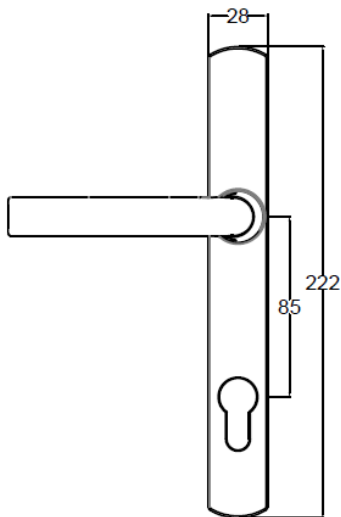

SPECIFICATION

Lever/handle:

High purity Zinc Alloy

Plate:

High purity Zinc Alloy

Plate Dimensions:

222 x 28 x 12mm

Door Thickness:

32 - 45mm

Fixing:

Back-to-back through door fixing, 2 x screws
M4x65mm

Spindle:

8mm standard spindle x 2

Handing:

Reversible (non-handed)

Lever handing is as simple as rotating the levers
180°.

Warranty:

10 Year mechanical

Finishes:

SC: Satin Chrome

BLK: Black

P5500-01 Euro Narrow Stile Entrance Set Lever N°1 & Snib

Lever N°1 Length: 121mm
 Lever Standoff: 53mm
 Plate Length: 222mm
 Plate Width: 28mm

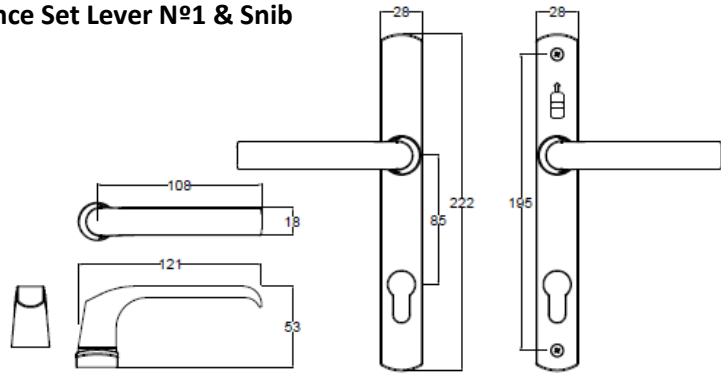

P5510-01 Euro Narrow Stile Entrance Set Lever N°1

Lever N°1 Length: 121mm
 Lever Standoff: 53mm
 Plate Length: 222mm
 Plate Width: 28mm

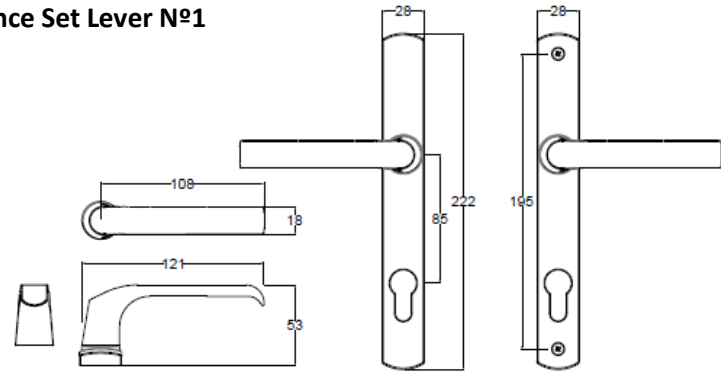

P5520-01 Euro Narrow Stile Patio Set Lever N°1 & Snib

Lever N°1 Length: 121mm
 Lever Standoff: 53mm
 Plate Length: 222mm
 Plate Width: 28mm

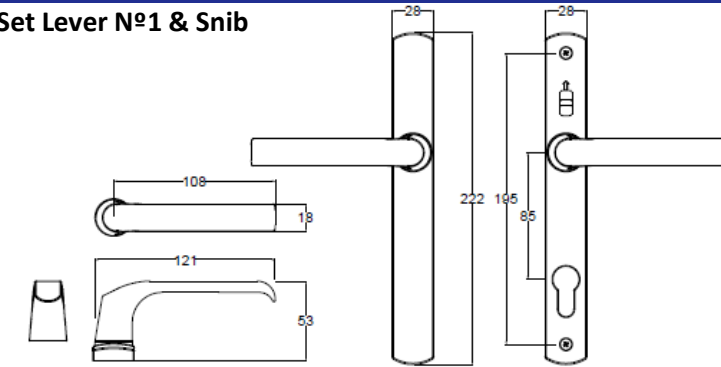

P5530-01 Euro Narrow Stile Passage Set Lever 01

Lever N°1 Length: 121mm
 Lever Standoff: 53mm
 Plate Length: 222mm
 Plate Width: 28mm

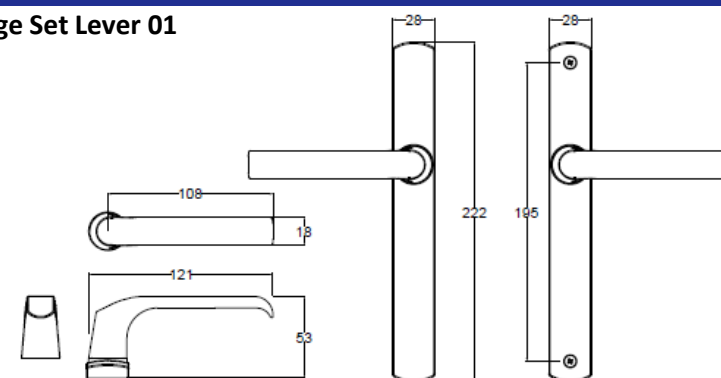

Product Code	Description	Finish
P5500-01	Euro Long Plate Entrance Set – Lever 01 & Snib	SC, BLK
P5510-01	Euro Long Plate Entrance Set – Lever 01	SC, BLK
P5520-01	Euro Long Plate Patio Set – Lever 01	SC, BLK
P5530-01	Euro Long Plate Passage Set – Lever 01	SC, BLK

